



## Product Model Number

**CKO-SA15-075033-4009**

### ✓ Model Number Definitions

**CKO-XXXX-XXXXXX-XXXX**

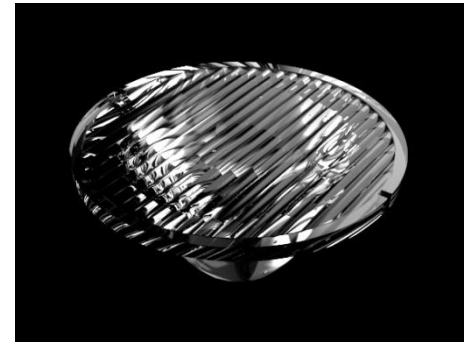

- A. Chun Kuang Optics Corp. Product
- B. Product Type: product abbreviation  
Ex:  
CH→CoB High Intensity  
CC→CoB Compact  
CS→Soft Shading for CoB LED  
HC→Holder for CoB LED

- C. Identity Code
- D. Lens / Fixture Size  
Ex: 075026=Φ75mm / Thickness=26mm (round up)
- E. Serial Numbers

The lens datasheet is applicable for **Citizen LED**, that manufactured by Chun Kuang Optics Corp.

### ✓ Dimensions (mm) : Φ75 x 33

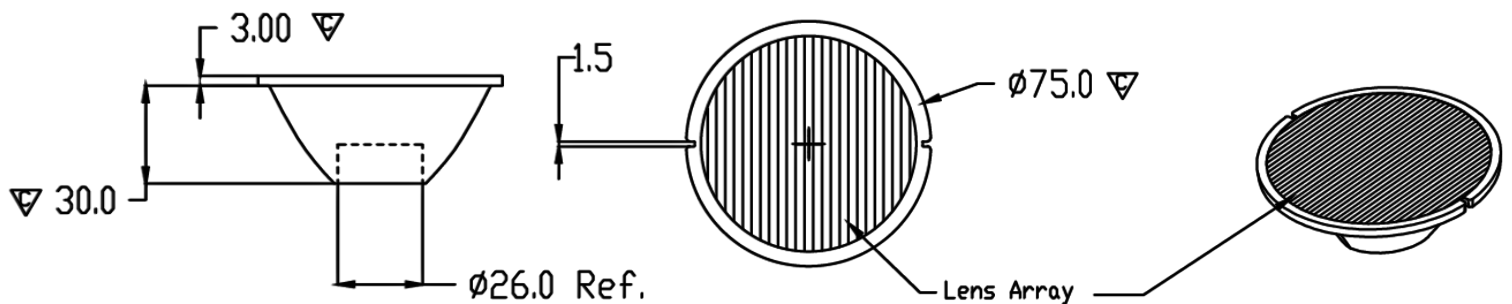

▽:Critical Dimension





## Optical Characteristics

Model Number	CKO-SA15-075033-4009		<p>"H" definition</p>
LED	CLU 711		
LES / LED Size	Φ 8.5 mm		
FWHM (D50)	25°x37°		
Field Angle (D10)	35°x75°		
H (distance)	3.65 mm		
Dimension	Φ =75 mm, Thickness=33 mm		
Luminous Flux	2754 lm	Measured @ 25.6 W	
Material	PC / UL94V2		

## cd/klm

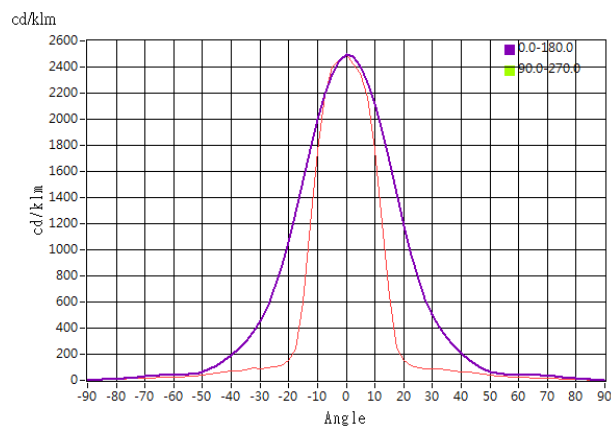

## Illuminance At Distances

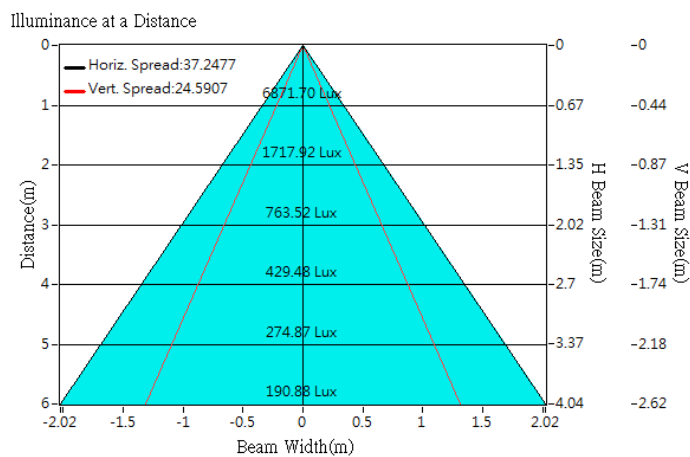



## Optical Characteristics

Model Number	CKO-SA15-075033-4009		<p>"H" definition</p>
LED	CLU 028		
LES / LED Size	Φ 9.8 mm		
FWHM (D50)	30°x39°		
Field Angle (D10)	40°x78°		
H (distance)	3.65 mm		
Dimension	Φ =75 mm, Thickness=33 mm		
Luminous Flux	1455 lm	Measured @ 12.5 W	
Material	PC / UL94V2		

## cd/klm

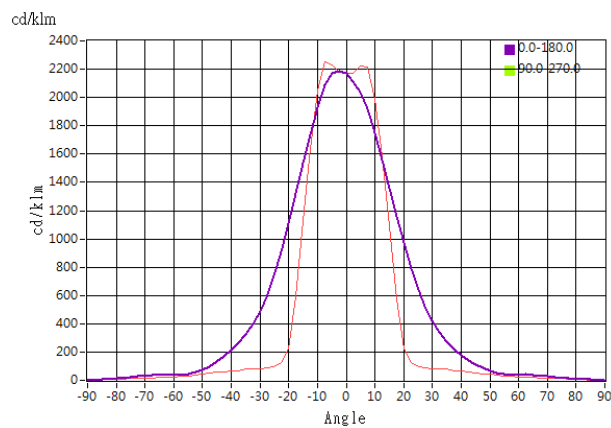

## Illuminance At Distances

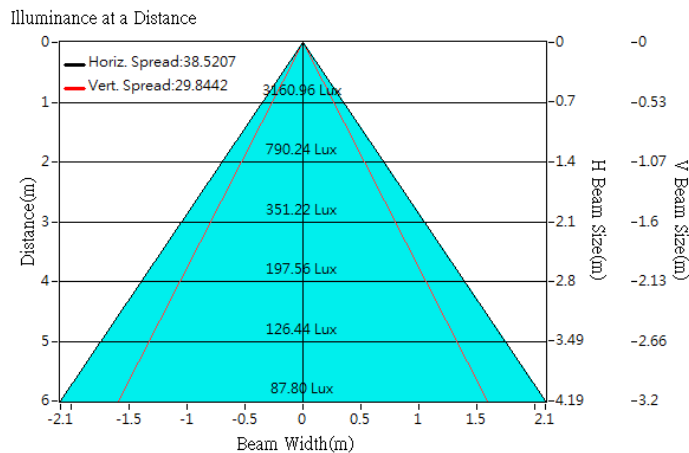



## Optical Characteristics

Model Number	CKO-SA15-075033-4009		<p>"H" definition</p>
LED	CLU 038		
LES / LED Size	Φ 14.5 mm		
FWHM (D50)	26x°39°		
Field Angle (D10)	41°x78°		
H (distance)	3.65 mm		
Dimension	Φ =75 mm, Thickness=33 mm		
Luminous Flux	2697 lm	Measured @ 25.4 W	
Material	PC / UL94V2		

## cd/klm

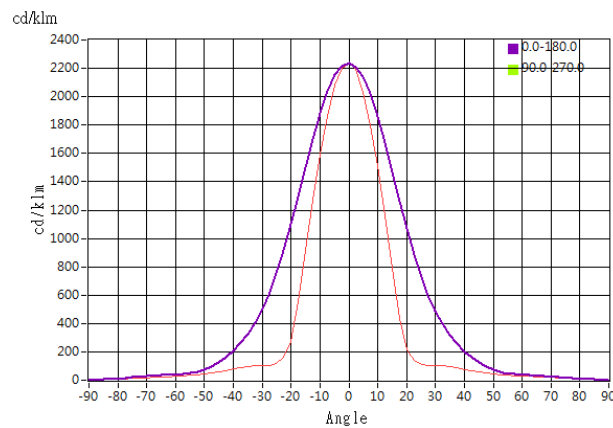

## Illuminance At Distances

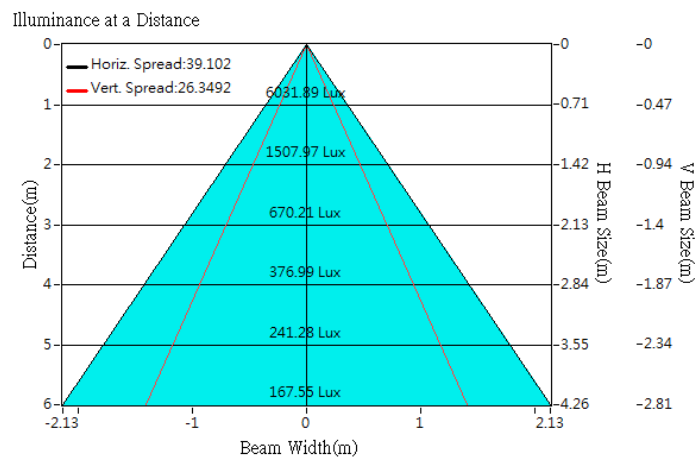

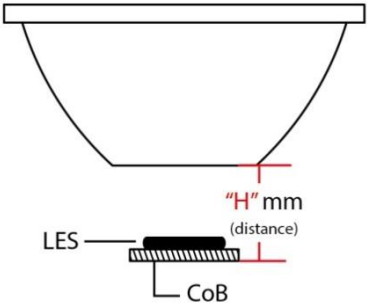

## Optical Characteristics

Model Number	CKO-SA15-075033-4009		<p>"H" definition</p> 
LED	CLU 036		
LES / LED Size	Φ 14.5 mm		
FWHM (D50)	30°x39°		
Field Angle (D10)	45°x79°		
H (distance)	3.65 mm		
Dimension	Φ =75 mm, Thickness=33 mm		
Luminous Flux	1885 lm	Measured @ 15.7 W	
Material	PC / UL94V2		

## cd/klm

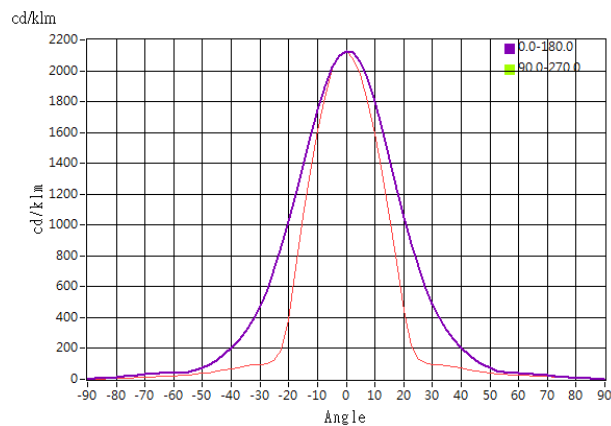

## Illuminance At Distances

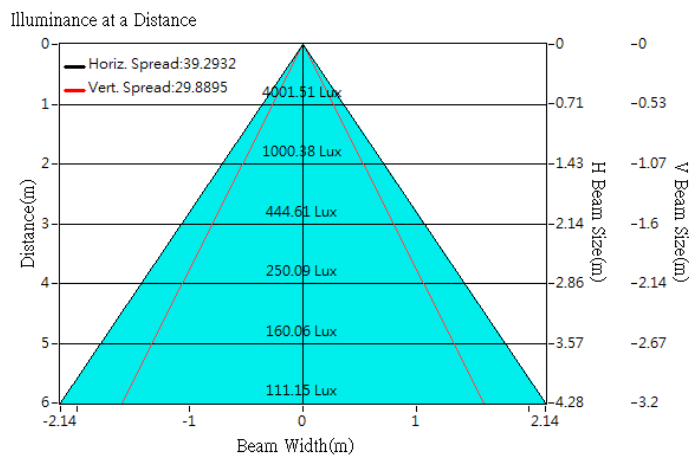



## Optical Characteristics

Model Number	CKO-SA15-075033-4009		<p>"H" definition</p>
LED	CLU 048		
LES / LED Size	Φ 22 mm		
FWHM (D50)	35°x42°		
Field Angle (D10)	62°x83°		
H (distance)	3.65 mm		
Dimension	Φ =75 mm, Thickness=33 mm		
Luminous Flux	6514 lm	Measured @ 53.7 W	
Material	PC / UL94V2		

## cd/klm

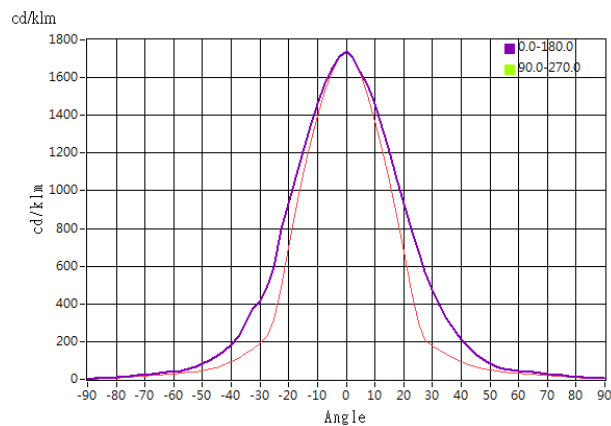

## Illuminance At Distances

