



Product Model Number

CKO-SA18-035018-1309

✓ Model Number Definitions

CKO-XXXX-XXXXXX-XXXX



- A. Chun Kuang Optics Corp. Product
- B. Product Type: product abbreviation
Ex:
CH→CoB High Intensity
CC→CoB Compact
CS→Soft Shading for CoB LED
HC→Holder for CoB LED

- C. Identity Code
- D. Lens / Fixture Size
Ex: 075026=Φ75mm / Thickness=26mm (round up)
- E. Serial Numbers

The lens datasheet is applicable for **Citizen LED**, that manufactured by Chun Kuang Optics Corp.

✓ Dimensions (mm) : Φ35 x 17.4

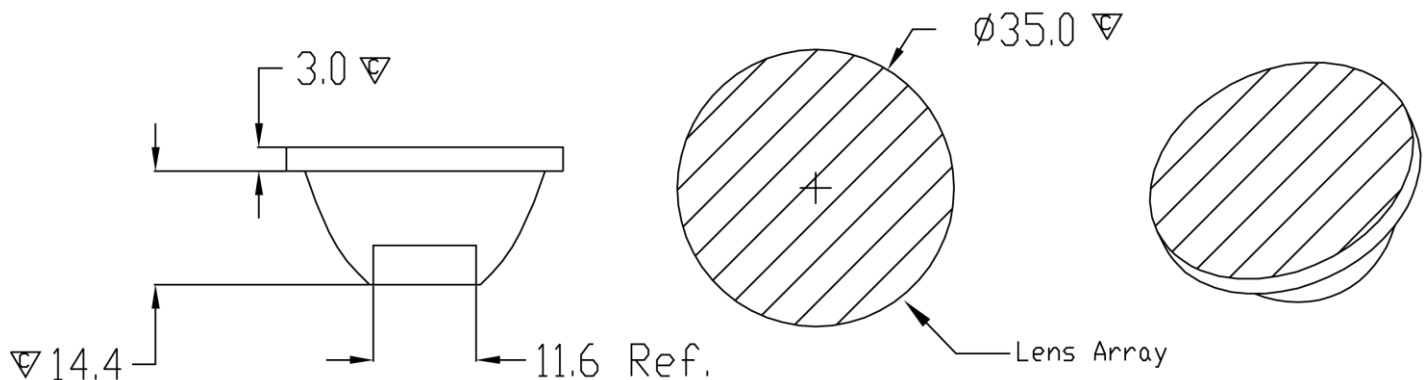

▽:Critical Dimension



Optical Characteristics

Model Number	CKO-SA18-035018-1309		<p>"H" definition</p>
LED	CLU 700		
LES / LED Size	Φ 6 mm		
FWHM (D50)	18°x32°		
Field Angle (D10)	41°x56°		
H (distance)	2.5mm		
Dimension	Φ =35 mm, Thickness=17.4 mm		
Luminous Flux	1362 lm	Measured @ 14.5 W	
Material	PC / UL94V2		

cd/klm

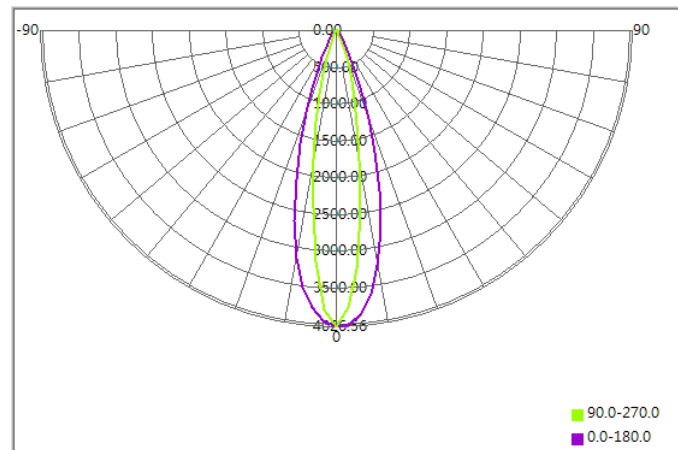

Illuminance At Distances

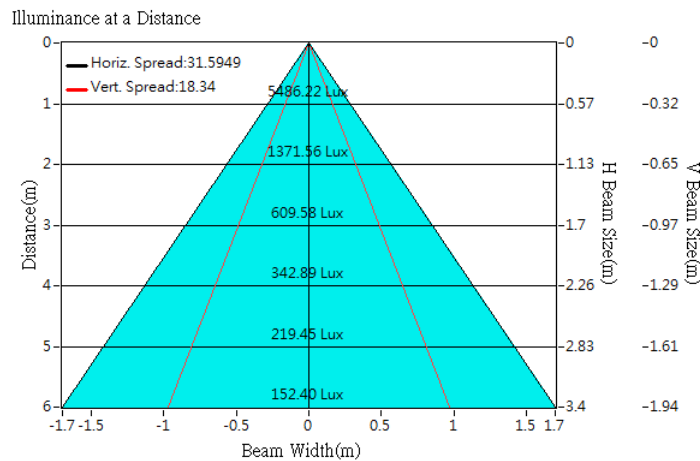



Optical Characteristics

Model Number	CKO-SA18-035018-1309		<p>"H" definition</p>
LED	CLU 701		
LES / LED Size	Φ 6 mm		
FWHM (D50)	18°x33°		
Field Angle (D10)	42°x58°		
H (distance)	2.5mm		
Dimension	Φ =35 mm, Thickness=17.4 mm		
Luminous Flux	1183 lm	Measured @ 10.8 W	
Material	PC / UL94V2		

cd/klm

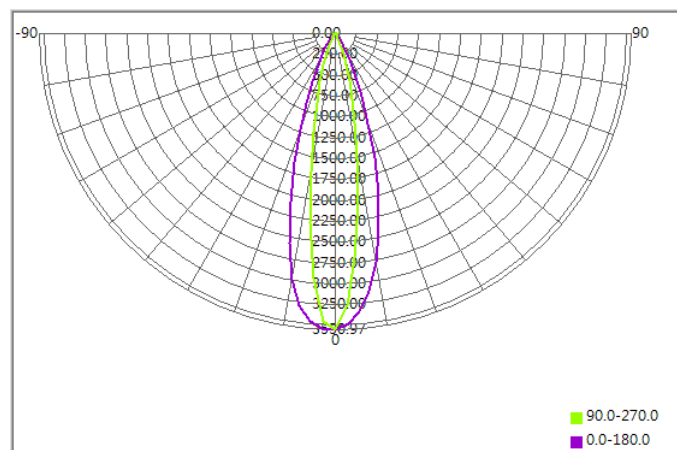

Illuminance At Distances

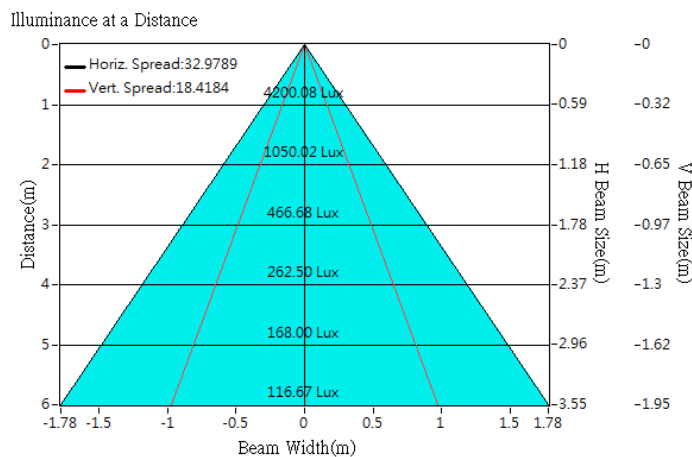



Optical Characteristics

Model Number	CKO-SA18-035018-1309		<p>"H" definition</p> <p>LES CoB</p>
LED	CLU 710		
LES / LED Size	Φ 8.5 mm		
FWHM (D50)	24°x33°		
Field Angle (D10)	53°x64°		
H (distance)	2.5mm		
Dimension	Φ =35 mm, Thickness=17.4 mm		
Luminous Flux	2496 lm	Measured @ 26.46 W	
Material	PC / UL94V2		

cd/klm

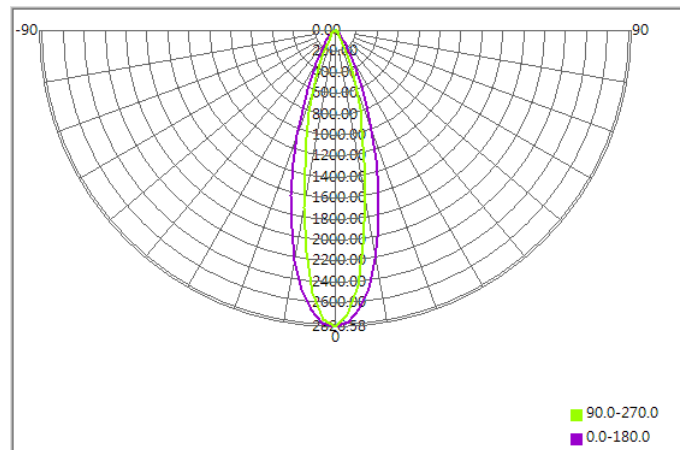

Illuminance At Distances

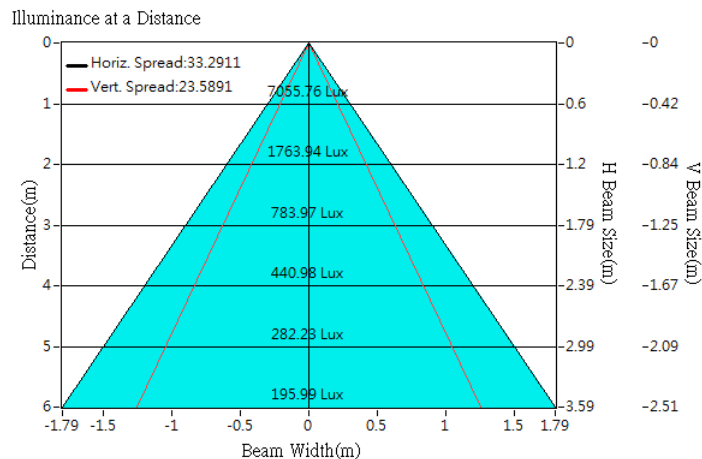



Optical Characteristics

Model Number	CKO-SA18-035018-1309		<p>"H" definition</p>
LED	CLU 711		
LES / LED Size	Φ 8.5 mm		
FWHM (D50)	24°x33°		
Field Angle (D10)	52°x64°		
H (distance)	2.5mm		
Dimension	Φ =35 mm, Thickness=17.4 mm		
Luminous Flux	2701 lm	Measured @ 26.6 W	
Material	PC / UL94V2		

cd/klm

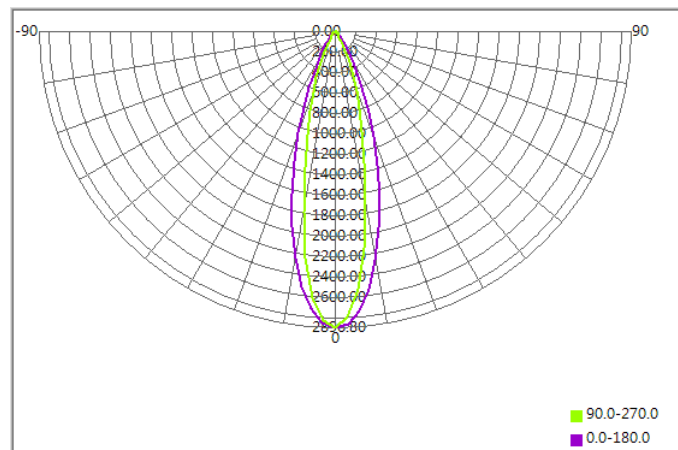

Illuminance At Distances

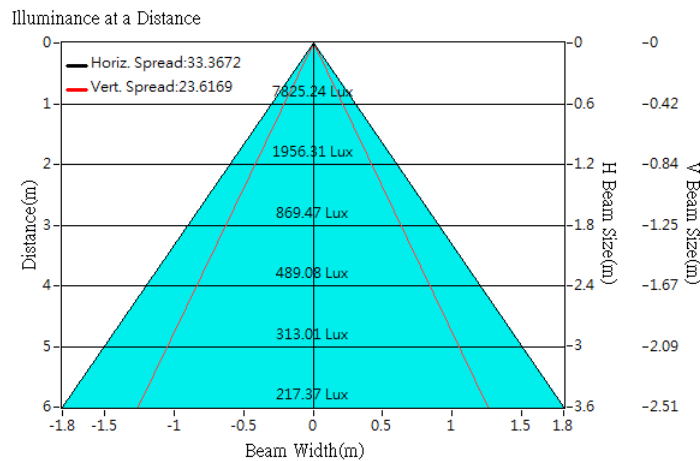



Optical Characteristics

Model Number	CKO-SA18-035018-1309		<p>"H" definition</p>
LED	CLU 026		
LES / LED Size	Φ 9.8 mm		
FWHM (D50)	25°x35°		
Field Angle (D10)	58°x70°		
H (distance)	2.5mm		
Dimension	Φ =35 mm, Thickness=17.4 mm		
Luminous Flux	1559 lm	Measured @ 12.5 W	
Material	PC / UL94V2		

cd/klm

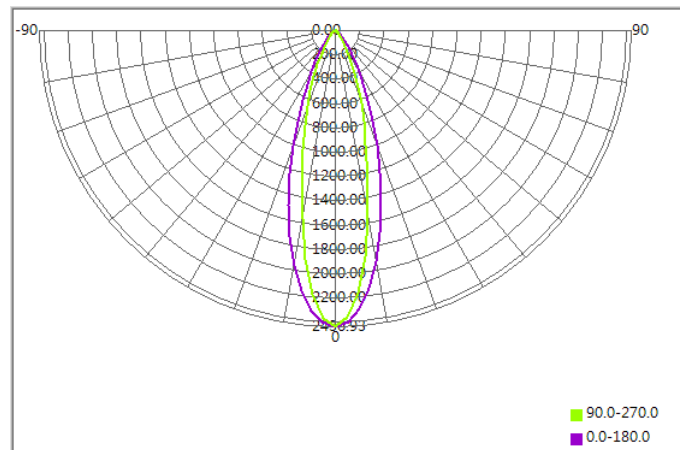

Illuminance At Distances

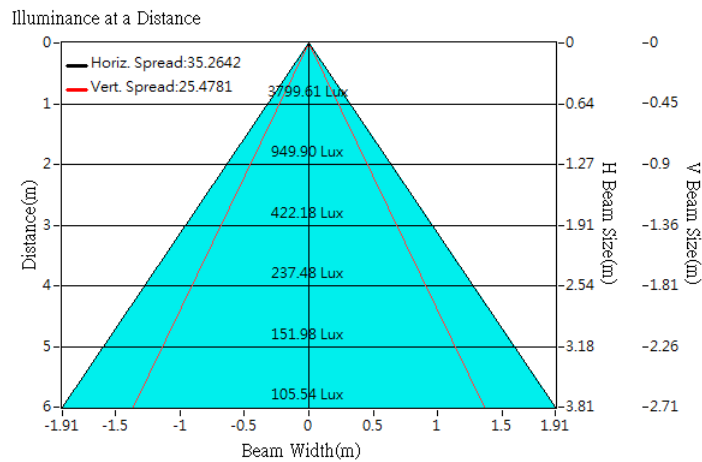



Optical Characteristics

Model Number	CKO-SA18-035018-1309		<p>"H" definition</p>
LED	CLU 028		
LES / LED Size	Φ 9.8 mm		
FWHM (D50)	26°x35°		
Field Angle (D10)	58°x68°		
H (distance)	2.5mm		
Dimension	Φ =35 mm, Thickness=17.4 mm		
Luminous Flux	1616 lm	Measured @ 12.5 W	
Material	PC / UL94V2		

cd/klm

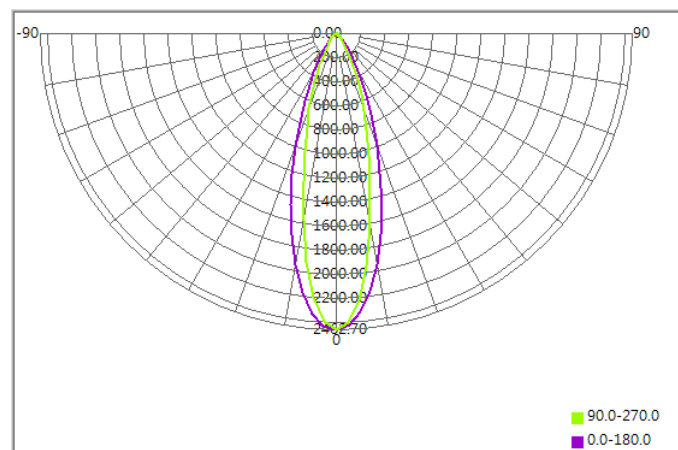

Illuminance At Distances

