



## Product Model Number

**CKO-SA18-035018-1309**

### ✓ Model Number Definitions

**CKO-XXXX-XXXXXX-XXXX**



- A. Chun Kuang Optics Corp. Product
- B. Product Type: product abbreviation  
Ex:  
CH→CoB High Intensity  
CC→CoB Compact  
CS→Soft Shading for CoB LED  
HC→Holder for CoB LED

- C. Identity Code
- D. Lens / Fixture Size  
Ex: 075026=Φ75mm / Thickness=26mm (round up)
- E. Serial Numbers

The lens datasheet is applicable for **Luminus LED**, that manufactured by Chun Kuang Optics Corp.

### ✓ Dimensions (mm) : Φ35 x 17.4

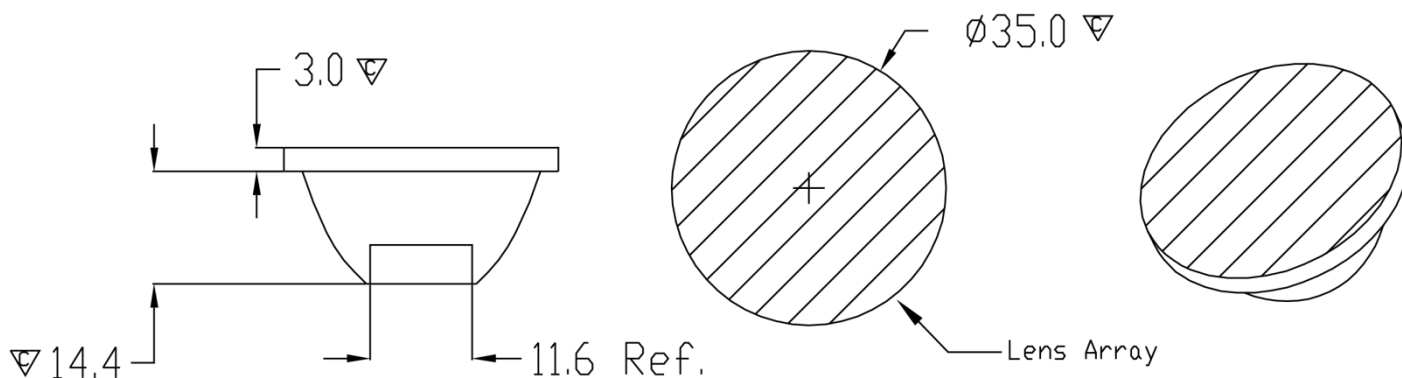

▽:Critical Dimension





## Optical Characteristics

Model Number	CKO-SA18-035018-1309		<p>"H" definition</p> <p>LES CoB</p>
LED	<b>CXM-3-AC40</b>		
LES / LED Size	Φ 3.5 mm		
FWHM (D50)	14°x32°		
Field Angle (D10)	33°x51°		
H (distance)	2.5 mm		
Dimension	Φ =35 mm, Thickness= 17.4 mm		
Luminous Flux	289 lm	Measured @ 2.7 W	
Material	PC / UL94V2		

## cd/klm

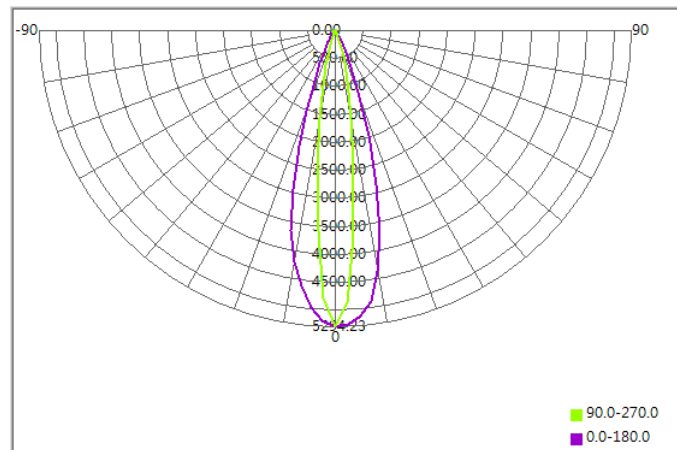

## Illuminance At Distances

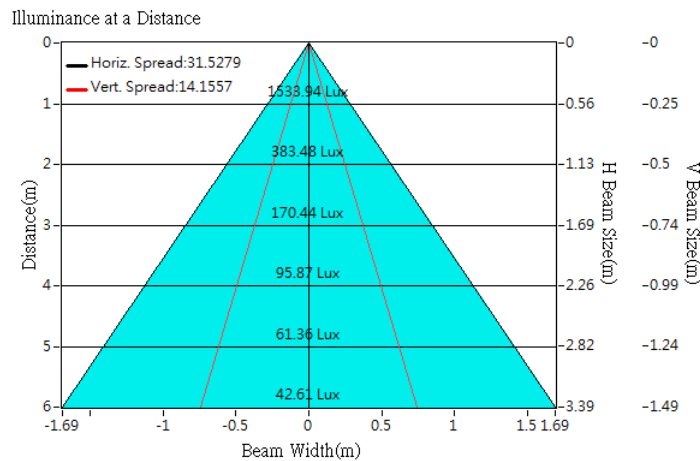



## Optical Characteristics

Model Number	CKO-SA18-035018-1309		<p>"H" definition</p>
LED	<b>CXM-4-AC40</b>		
LES / LED Size	Φ 4.5 mm		
FWHM (D50)	16°x31°		
Field Angle (D10)	36°x52°		
H (distance)	2.5 mm		
Dimension	Φ =35 mm, Thickness= 17.4 mm		
Luminous Flux	442 lm	Measured @ 4.0 W	
Material	PC / UL94V2		

## cd/klm

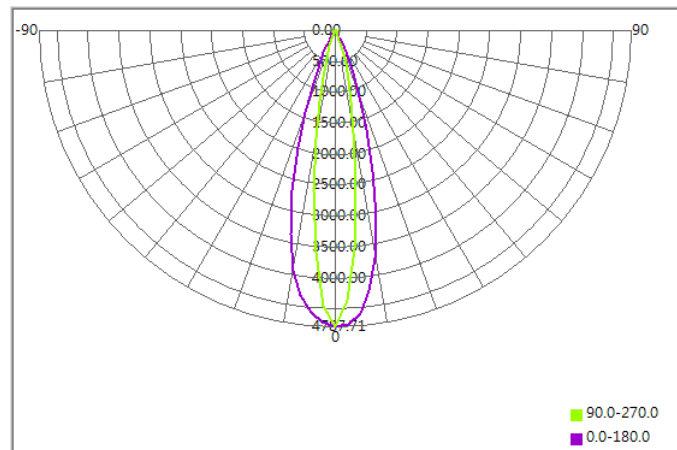

## Illuminance At Distances

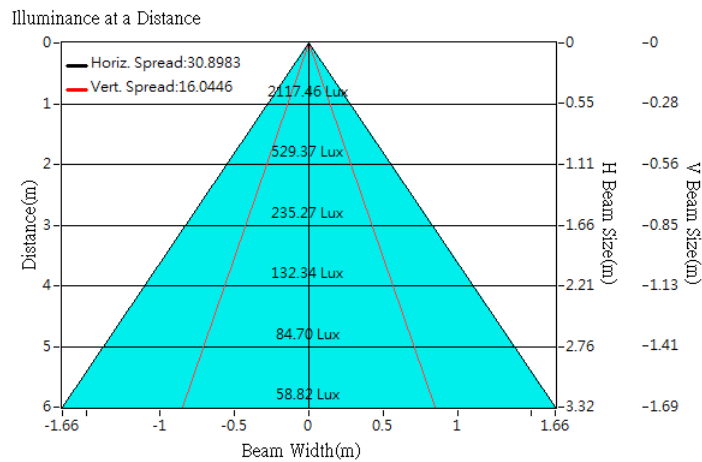



## Optical Characteristics

Model Number	CKO-SA18-035018-1309		<p>"H" definition</p>
LED	<b>CXM-6-AC40</b>		
LES / LED Size	Φ 6.3 mm		
FWHM (D50)	20°x32°		
Field Angle (D10)	46°x60°		
H (distance)	2.5 mm		
Dimension	Φ =35 mm, Thickness= 17.4 mm		
Luminous Flux	680 lm	Measured @ 5.2 W	
Material	PC / UL94V2		

## cd/klm

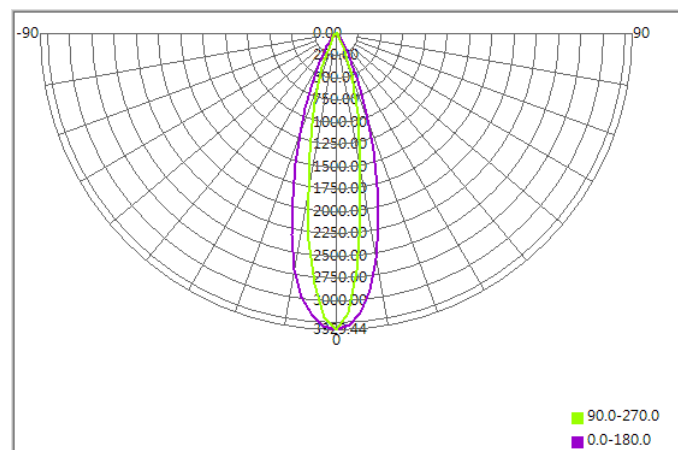

## Illuminance At Distances

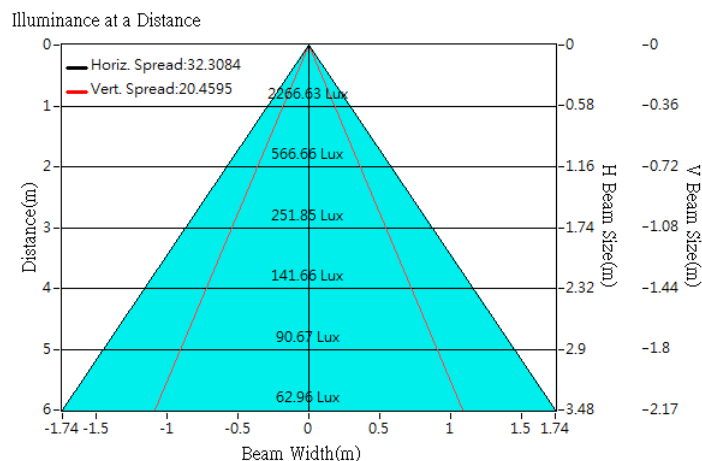



## Optical Characteristics

Model Number	CKO-SA18-035018-1309		<p>"H" definition</p>
LED	<b>CXM-9-AC30</b>		
LES / LED Size	Φ 9.6 mm		
FWHM (D50)	25°x35°		
Field Angle (D10)	57°x69°		
H (distance)	2.5 mm		
Dimension	Φ =35 mm, Thickness= 17.4 mm		
Luminous Flux	1438 lm	Measured @ 12.1 W	
Material	PC / UL94V2		

## cd/klm

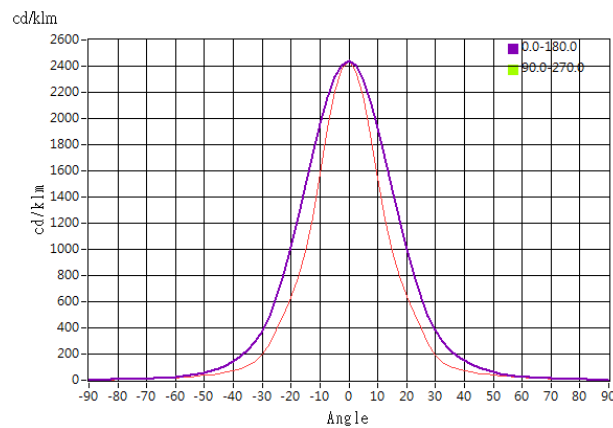

## Illuminance At Distances

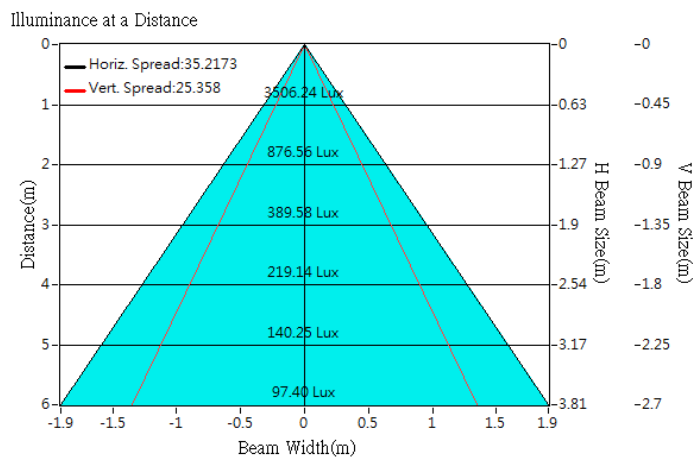



## Optical Characteristics

Model Number	CKO-SA18-035018-1309		<p>"H" definition</p>
LED	<b>CXM-9-AC40</b>		
LES / LED Size	Φ 9.8 mm		
FWHM (D50)	26°x36°		
Field Angle (D10)	60°x72°		
H (distance)	2.5 mm		
Dimension	Φ =35 mm, Thickness= 17.4 mm		
Luminous Flux	1388 lm	Measured @ 12.3 W	
Material	PC / UL94V2		

## cd/klm

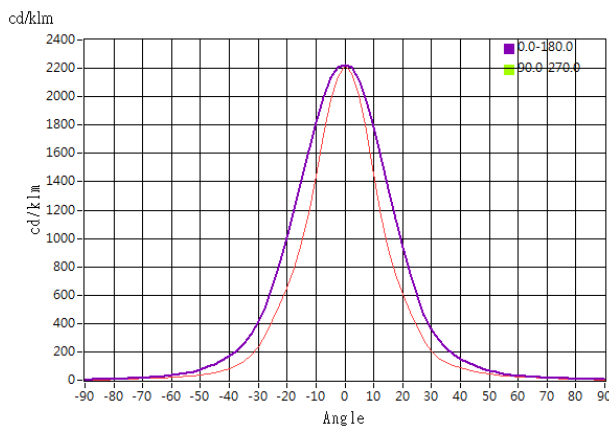

## Illuminance At Distances

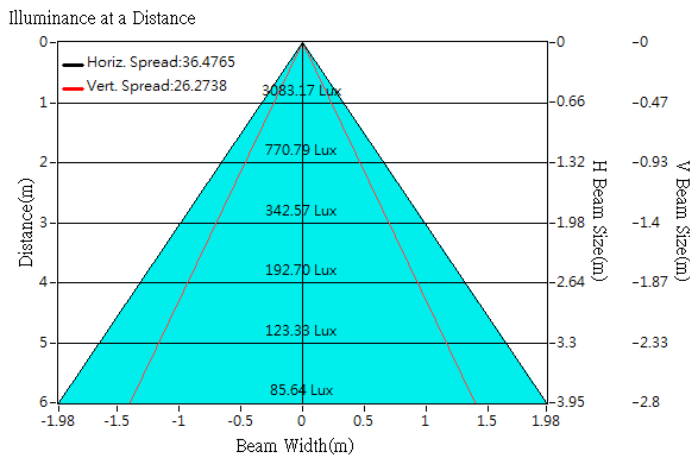



## Optical Characteristics

Model Number	CKO-SA18-035018-1309		<p>"H" definition</p> <p>LES CoB</p>
LED	<b>CXM-11-AC30</b>		
LES / LED Size	Φ 11.7 mm		
FWHM (D50)	30°		
Field Angle (D10)	67°		
H (distance)	2.5 mm		
Dimension	Φ =35 mm, Thickness= 17.4 mm		
Luminous Flux	1529 lm	Measured @ 15.4 W	
Material	PC / UL94V2		

## cd/klm

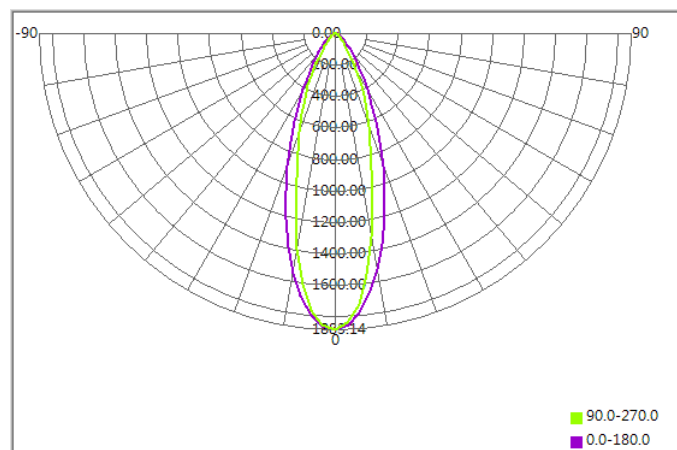

## Illuminance At Distances

