



Product Model Number

CKO-SP16-048025-2801

✓ Model Number Definitions

CKO-XXXX-XXXXXX-XXXX



- A. Chun Kuang Optics Corp. Product
- B. Product Type: product abbreviation
Ex:
CH→CoB High Intensity
CC→CoB Compact
CS→Soft Shading for CoB LED
HC→Holder for CoB LED

- C. Identity Code
- D. Lens / Fixture Size
Ex: 075026=Φ75mm / Thickness=26mm (round up)
- C. Serial Numbers

The lens datasheet is applicable for **CREE LED**, that manufactured by Chun Kuang Optics Corp.

✓ Dimensions (mm) : Φ48 x 25

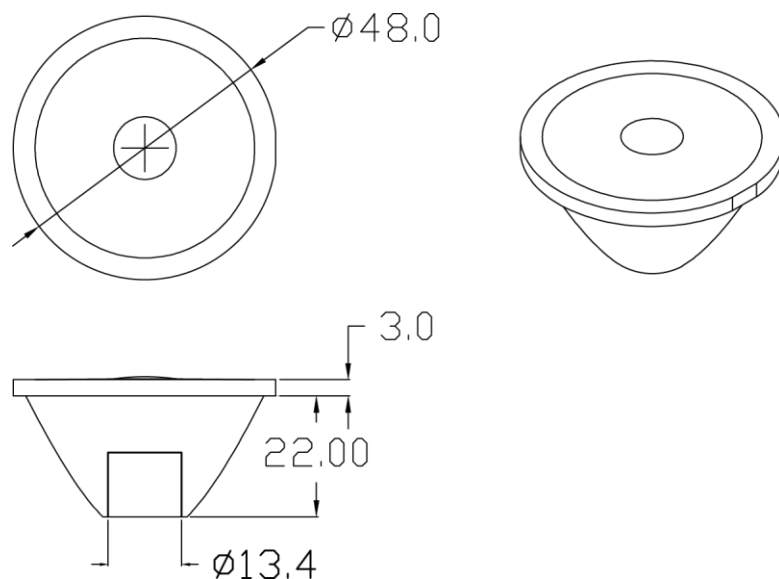

▽:Critical Dimension



Optical Characteristics

Model Number	CKO-SP16-048025-2801		
LED	XD 16		
LES / LED Size	1.6 x 1.6		
FWHM (D50)	4°		
Field Angle (D10)	8°		
Dimension with Holder	Φ =48 mm, Thickness=25 mm		
Luminous Flux	136lm	Measured @ 1.1 W	
Material	PC / UL94V2		

cd/klm

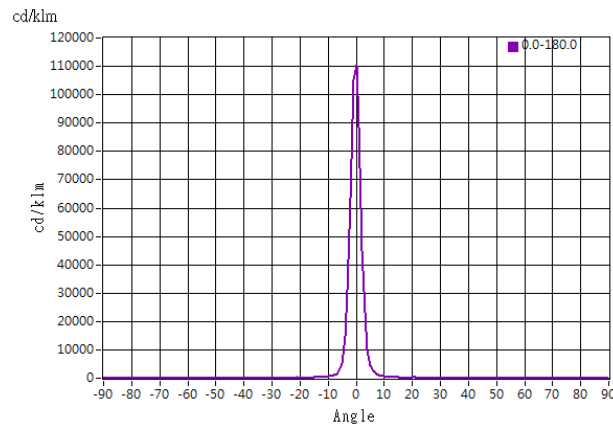

Illuminance At Distances

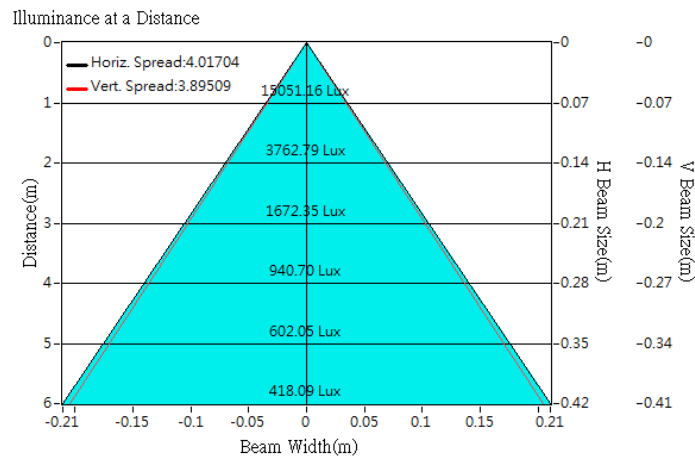



Optical Characteristics

Model Number	CKO-SP16-048025-2801		<p>Schematic Diagram</p> 
LED	Cree XQ-E HI		
LES / LED Size	1.6 x 1.6		
FWHM (D50)	2.7°		
Field Angle (D10)	7°		
Dimension with Holder	Φ =48 mm, Thickness=25 mm		
Luminous Flux	118 lm	Measured @ 1.1 W	
Material	PC / UL94V2		

cd/klm

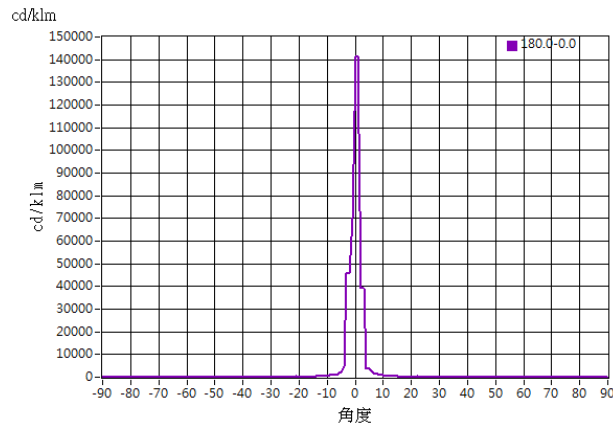

Illuminance At Distances

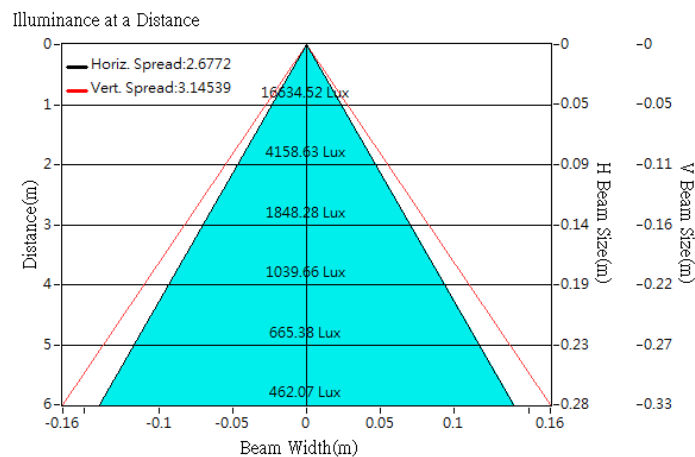



Optical Characteristics

Model Number	CKO-SP16-048025-2801		
LED	Cree XP-E2		
LES / LED Size	3.5 x 3.5		
FWHM (D50)	3.7°		
Field Angle (D10)	8°		
Dimension with Holder	Φ =48 mm, Thickness=25 mm		
Luminous Flux	134 lm	Measured @ 1.1 W	
Material	PC / UL94V2		

cd/klm

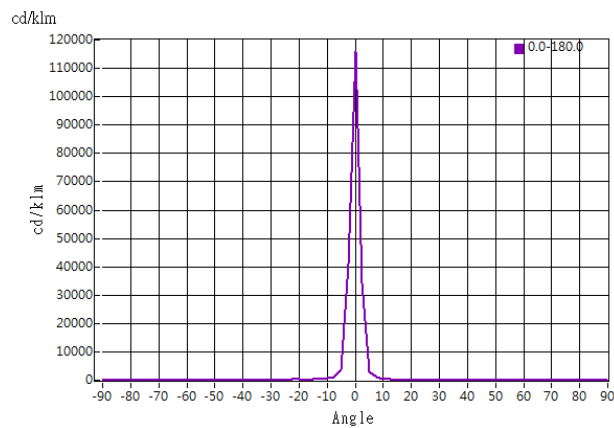

Illuminance At Distances

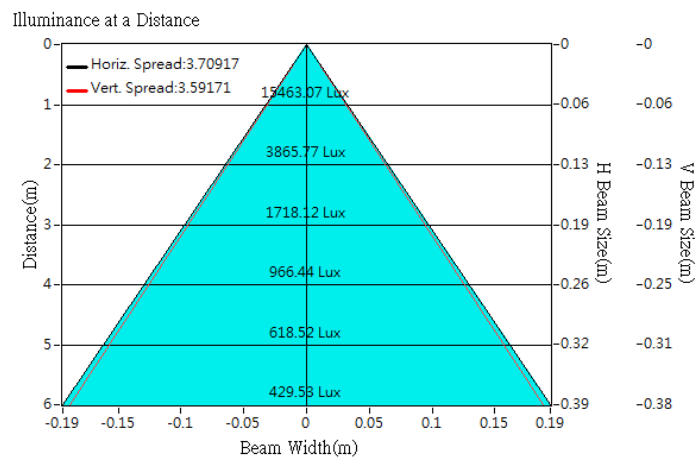



Optical Characteristics

Model Number	CKO-SP16-048025-2801		<p>Schematic Diagram</p>
LED	Cree XHP35-HI		
LES / LED Size	3.5 x 3.5		
FWHM (D50)	5°		
Field Angle (D10)	11°		
Dimension with Holder	Φ =48 mm, Thickness=25 mm		
Luminous Flux	476 lm	Measured @ 4.1 W	
Material	PC / UL94V2		

cd/klm

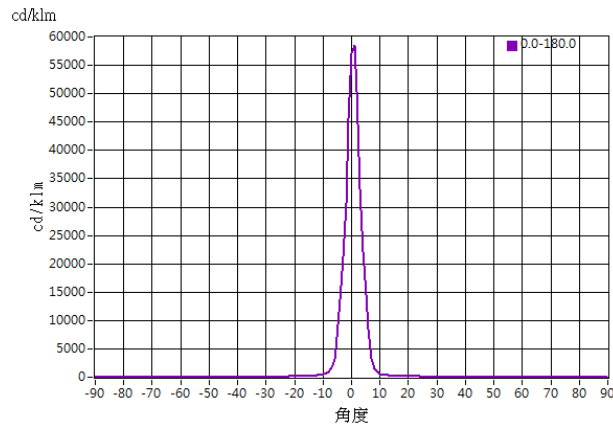

Illuminance At Distances

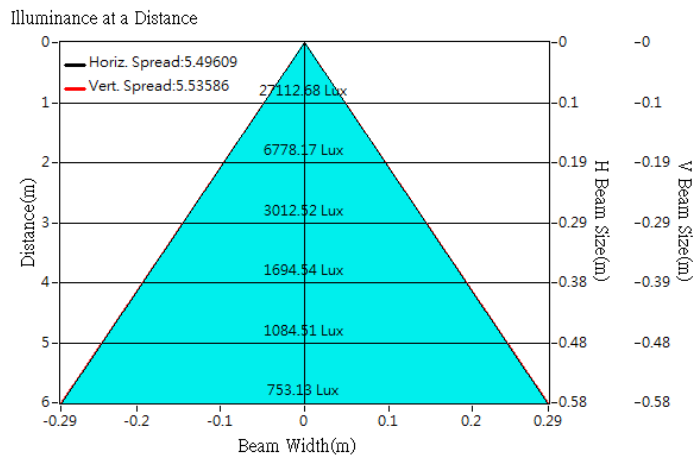



Optical Characteristics

Model Number	CKO-SP16-048025-2801		<p>Schematic Diagram</p> 
LED	Cree XP-L HI		
LES / LED Size	3.5 x 3.5		
FWHM (D50)	4.9°		
Field Angle (D10)	11°		
Dimension with Holder	Φ =48 mm, Thickness=25 mm		
Luminous Flux	404 lm	Measured @ 3.6 W	
Material	PC / UL94V2		

cd/klm

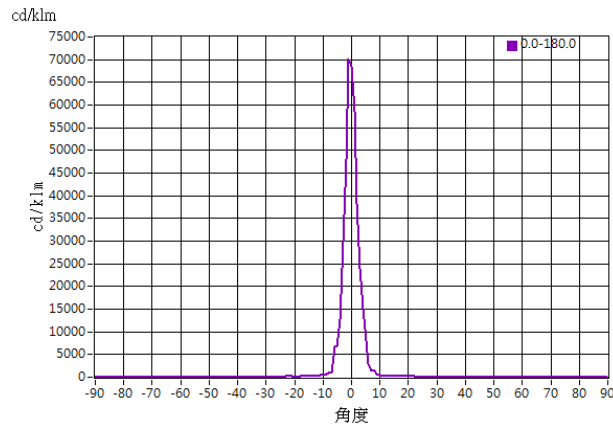

Illuminance At Distances

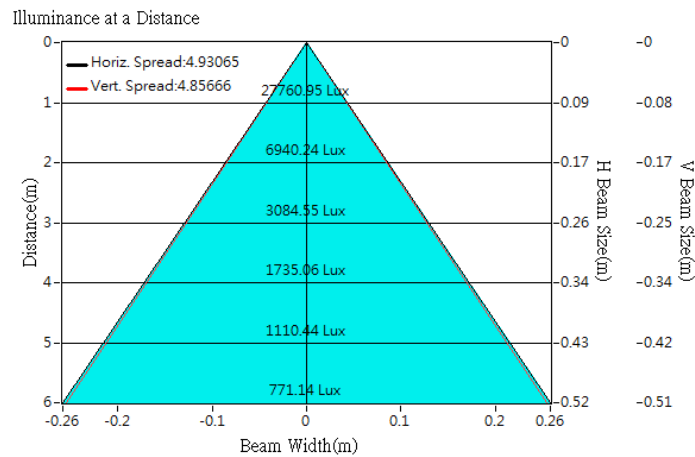



Optical Characteristics

Model Number	CKO-SP16-048025-2801		<p>Schematic Diagram</p> 
LED	Cree XP-G3		
LES / LED Size	3.5 x 3.5		
FWHM (D50)	5°		
Field Angle (D10)	11°		
Dimension with Holder	Φ =48 mm, Thickness=25 mm		
Luminous Flux	145 lm	Measured @ 1.0 W	
Material	PC / UL94V2		

cd/klm

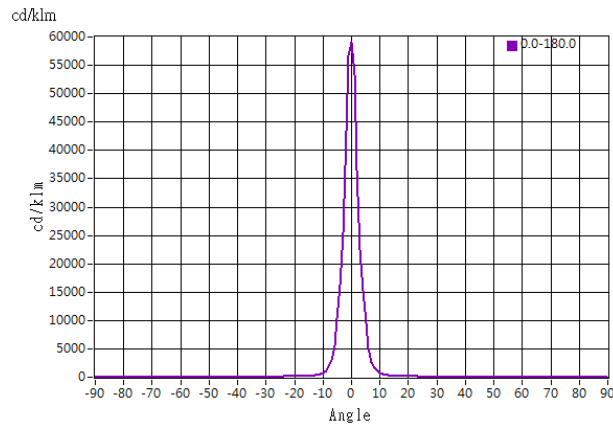

Illuminance At Distances

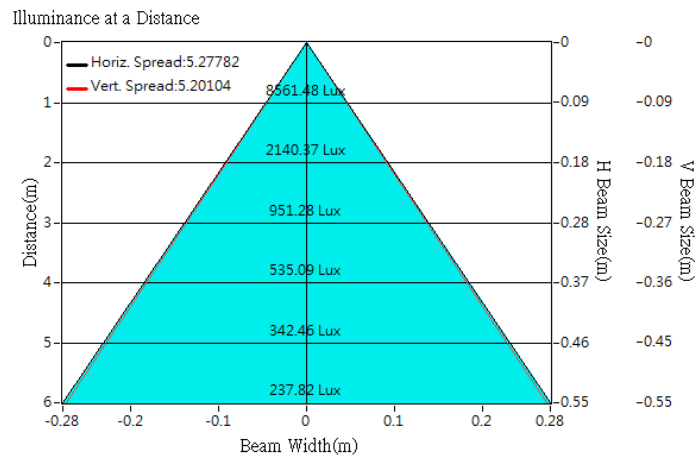



Optical Characteristics

Model Number	CKO-SP16-048025-2801		
LED	XP-L HD		
LES / LED Size	3.5 x 3.5		
FWHM (D50)	6°		
Field Angle (D10)	13°		
Dimension with Holder	Φ =32.8 mm, Thickness=25 mm		
Luminous Flux	367 lm	Measured @ 3.6 W	
Material	PC / UL94V2		

cd/klm

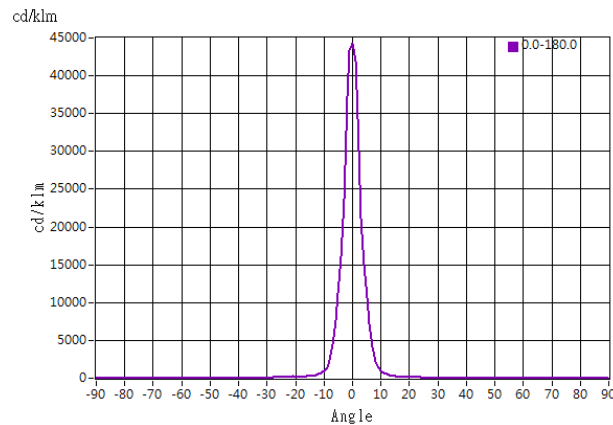

Illuminance At Distances

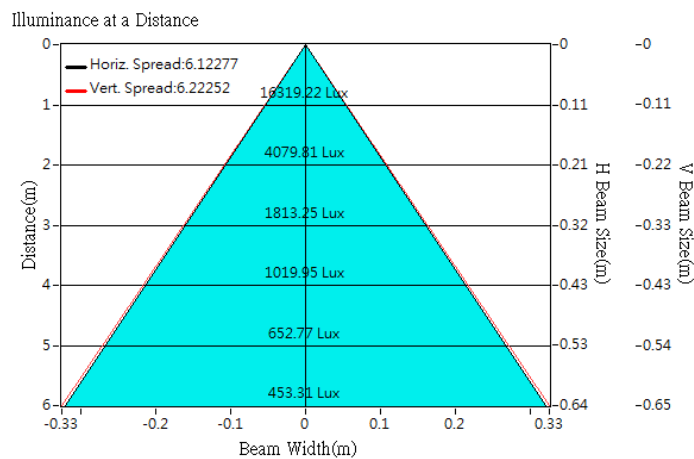



Lens Accessories - Lens Holder

Product Model	Size (mm)	Material
CKO-HL16-050028-3201	49.7 x 27.89	PC-V0

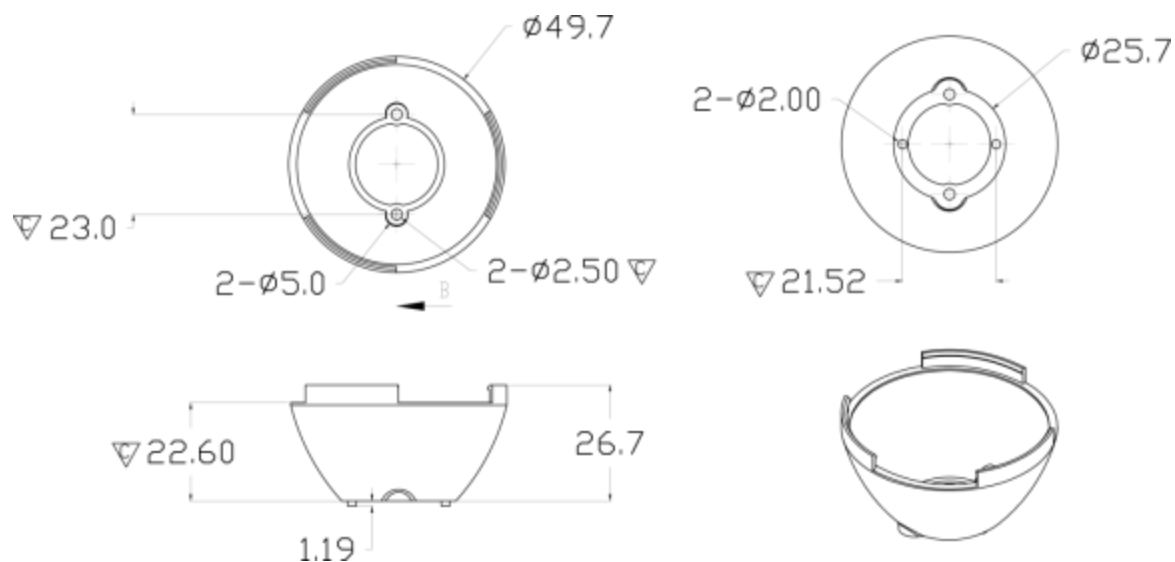

∇ :Critical Dimension