



Product Model Number

CKO-ZU15-034009-9803

✓ Model Number Definitions

CKO-XXXX-XXXXXX-XXXX



- A. Chun Kuang Optics Corp. Product
- B. Product Type: product abbreviation
Ex:
CH→CoB High Intensity
CC→CoB Compact
ZU→Multi-Angle Zooming Lens
HC→Holder for CoB LED

- C. Identity Code
- D. Lens / Fixture Size
Ex: 075026=Φ75mm / Thickness=26mm (round up)
- E. Serial Numbers

The lens datasheet is applicable for **Citizen LED**, that manufactured by Chun Kuang Optics Corp.

✓ Dimensions (mm) : Φ34 x 8.2

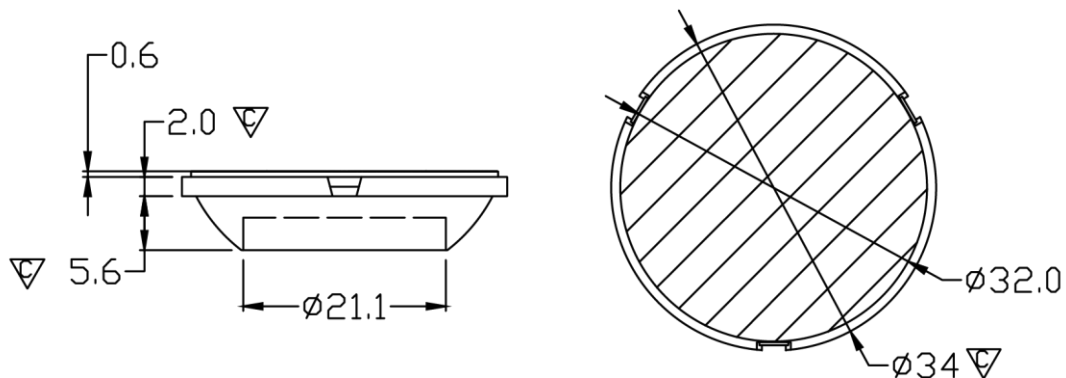

▽:Critical Dimension



Optical Characteristics

Model Number	CKO-ZU15-034009-9803
LED	CLU 700
LES / LED Size	Φ 6 mm
FWHM (D50)	21°-39°
Field Angle (D10)	47°-76°
H (distance)	1.75mm~-0.5mm
Dimension	Φ =34 mm, Thickness=8.2 mm
Luminous Flux	1421 lm ~ 1452 lm (21° ~ 39°) Measured @ 14 W
Material	PC / UL94V2

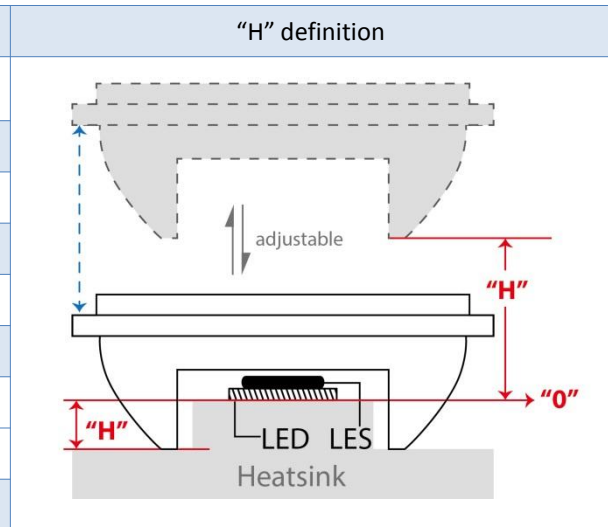

cd/klm

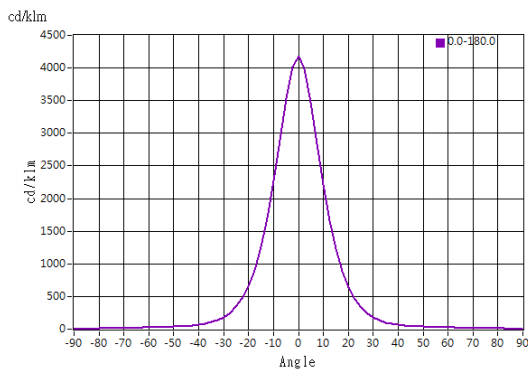

H: 1.75 mm

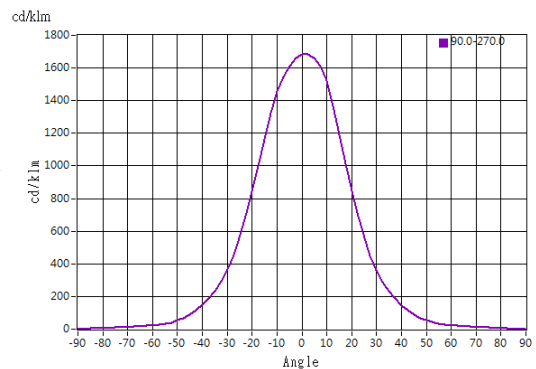

H: -0.5 mm

Illuminance At Distances

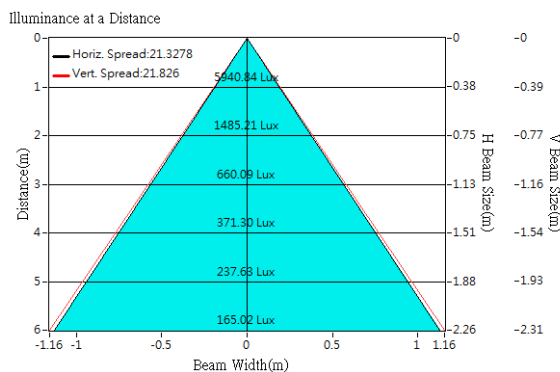

H: 1.75 mm

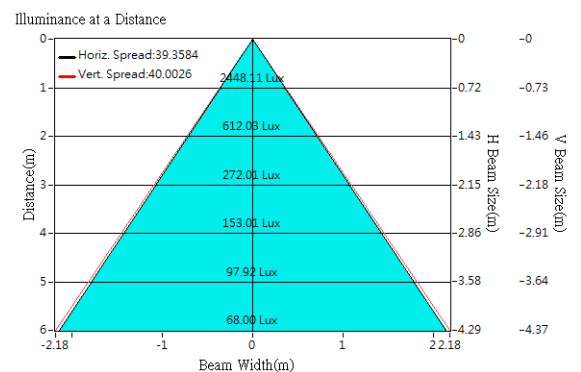

H: -0.5 mm



Optical Characteristics

Model Number	CKO-ZU15-034009-9803
LED	CLU 701
LES / LED Size	Φ 6 mm
FWHM (D50)	21°-38°
Field Angle (D10)	46°-73°
H (distance)	1.75mm~-0.5mm
Dimension	Φ =34 mm, Thickness=8.2 mm
Luminous Flux	1090 lm ~ 1137 lm (21° ~ 38°) Measured @ 10.8 W
Material	PC / UL94V2

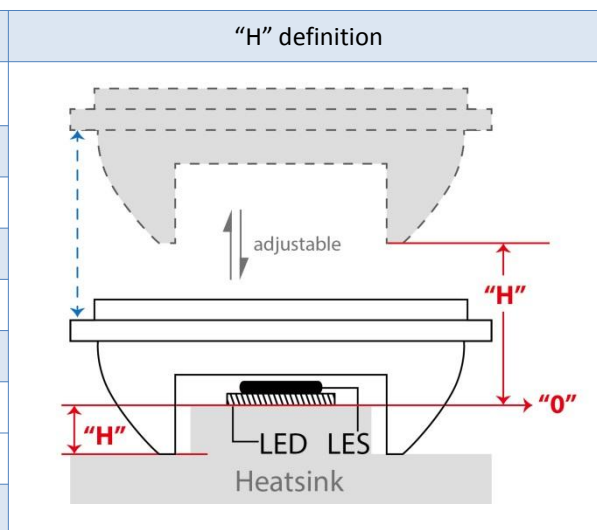

cd/klm

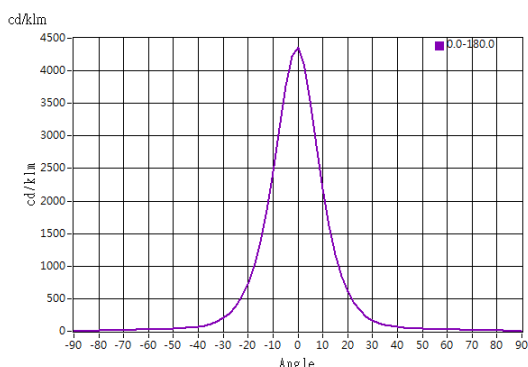

H: 1.5 mm

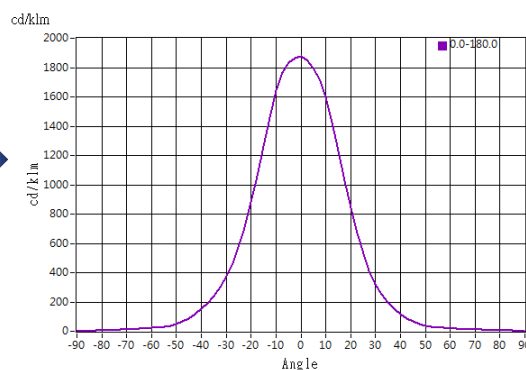

H: -0.5 mm

Illuminance At Distances

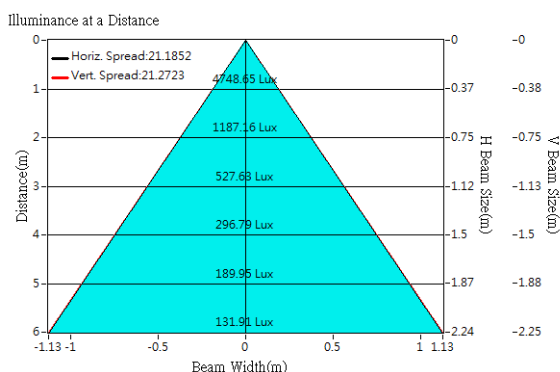

H: 1.5 mm

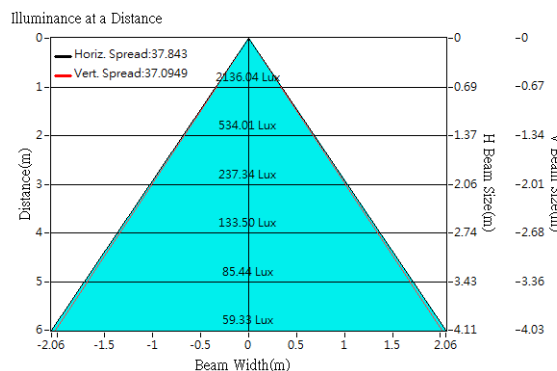

H: -0.5 mm



Optical Characteristics

Model Number	CKO-ZU15-034009-9803
LED	CLU 026
LES / LED Size	Φ 9.8 mm
FWHM (D50)	29°-40°
Field Angle (D10)	70°-91°
H (distance)	1.30mm~-0.5mm
Dimension	Φ =34 mm, Thickness=8.2 mm
Luminous Flux	1596 lm ~ 1643 lm (29° ~ 40°) Measured @ 13 W
Material	PC / UL94V2

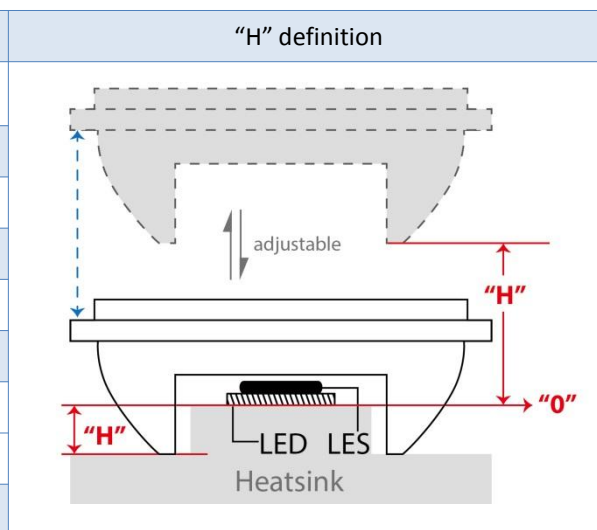

cd/klm

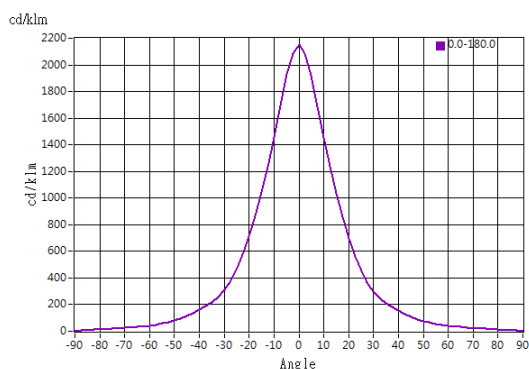

H: 1.3 mm

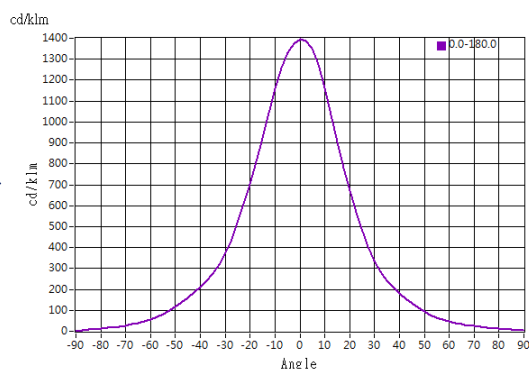

H: -0.5 mm

Illuminance At Distances

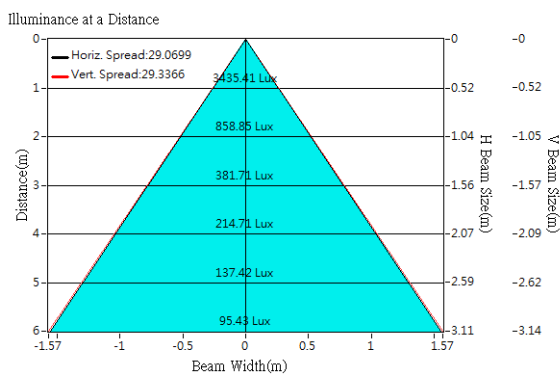

H: 1.3 mm

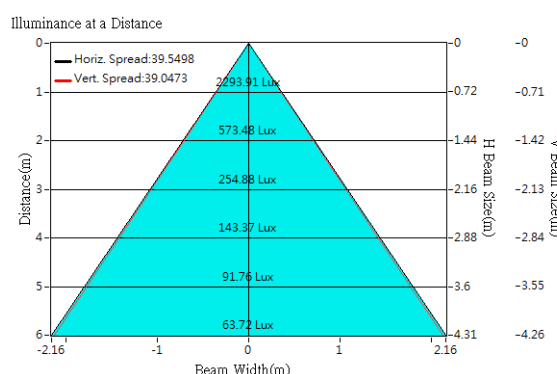

H: -0.5 mm



Optical Characteristics

Model Number	CKO-ZU15-034009-9803
LED	CLU 028
LES / LED Size	Φ 9.8 mm
FWHM (D50)	29°-40°
Field Angle (D10)	67°-91°
H (distance)	1.55mm~-0.5mm
Dimension	Φ =34 mm, Thickness=8.2 mm
Luminous Flux	1744 lm ~ 1787 lm (29° ~ 40°) Measured @ 12.4 W
Material	PC / UL94V2

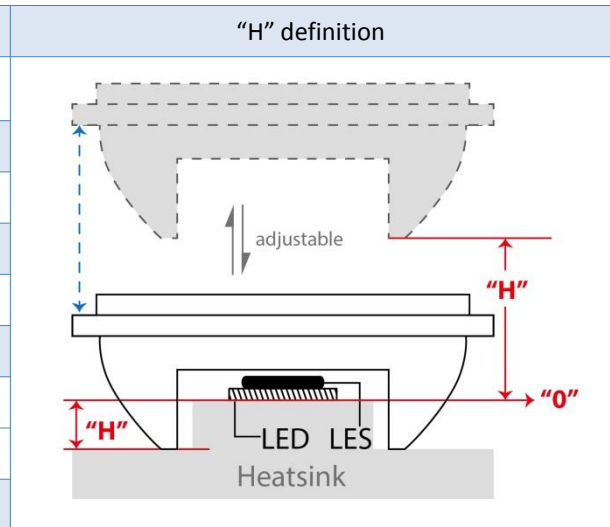

cd/klm

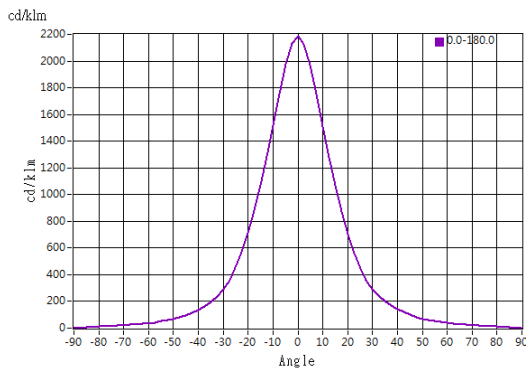

H: 1.55 mm

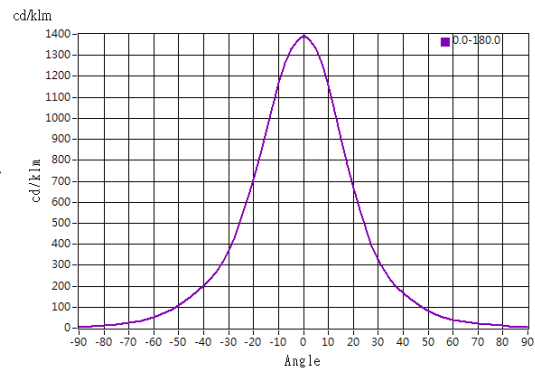

H: -0.5 mm

Illuminance At Distances

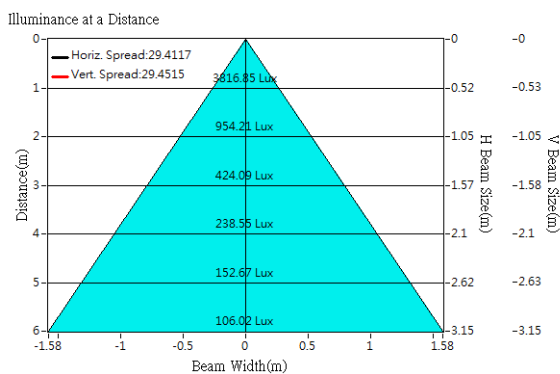

H: 1.55 mm

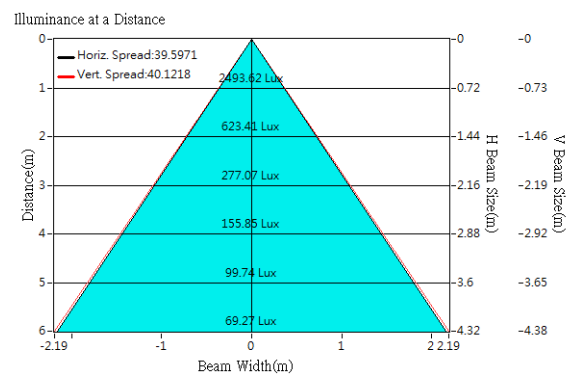

H: -0.5 mm