



Product Model Number

CKO-ZU15-034009-9803

✓ Model Number Definitions

CKO-XXXX-XXXXXX-XXXX



- A. Chun Kuang Optics Corp. Product
- B. Product Type: product abbreviation
Ex:
CH→CoB High Intensity
CC→CoB Compact
ZU→Multi-Angle Zooming Lens
HC→Holder for CoB LED

- C. Identity Code
- D. Lens / Fixture Size
Ex: 075026=Φ75mm / Thickness=26mm (round up)
- E. Serial Numbers

The lens datasheet is applicable for **Cree LED**, that manufactured by Chun Kuang Optics Corp.

✓ Dimensions (mm) : **Φ34 x 8.2**

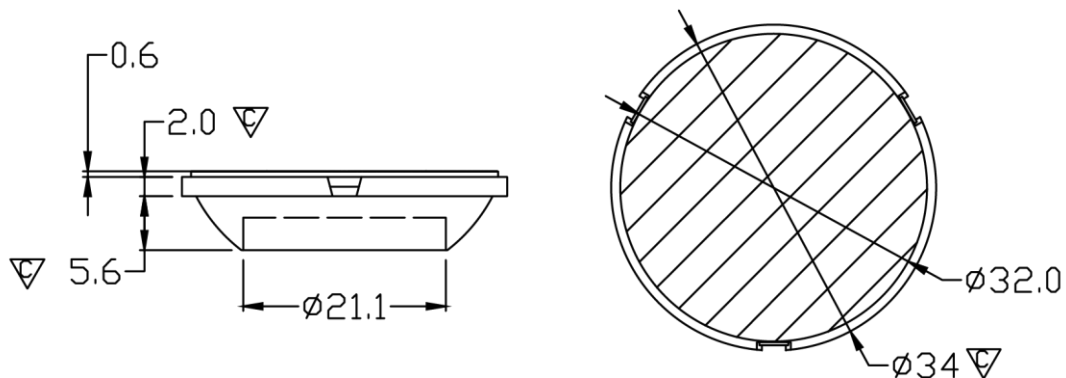

▽:Critical Dimension



Optical Characteristics

Model Number	CKO-ZU15-034009-9803
LED	CXA1304
LES / LED Size	Φ 6 mm
FWHM (D50)	21°-45°
Field Angle (D10)	46°-83°
H (distance)	2.0mm~0.5mm
Dimension	Φ =34 mm, Thickness=8.2 mm
Luminous Flux	411 lm ~ 421 lm (21° ~ 45°) Measured @ 3.6 W
Material	PC / UL94V2

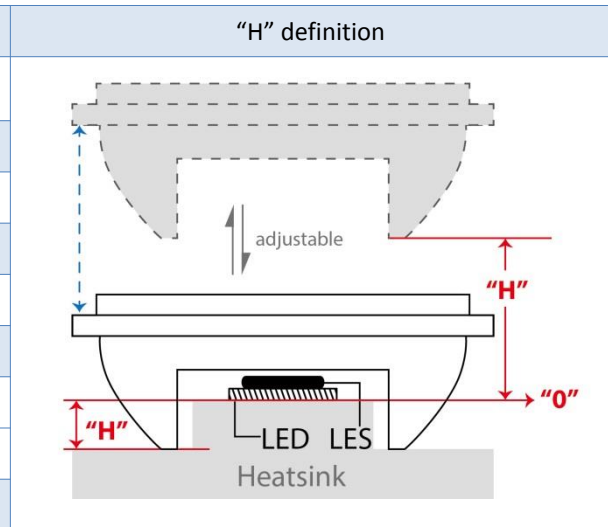

cd/klm

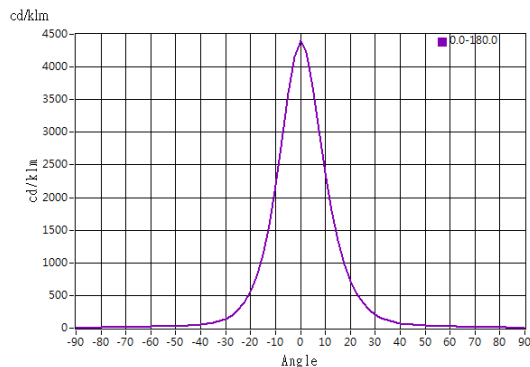

H: 2.0 mm

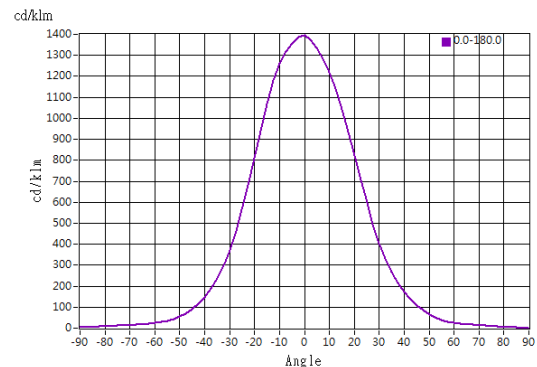

H: -0.5 mm

Illuminance At Distances

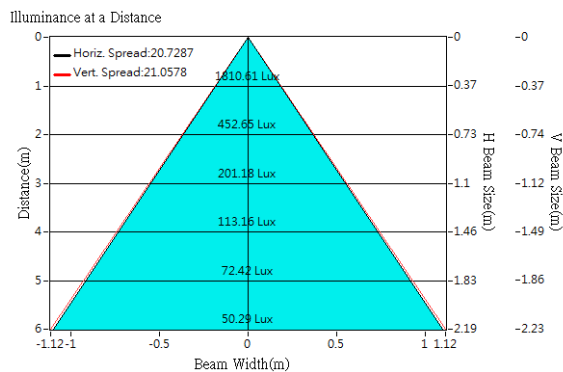

H: 2.0 mm

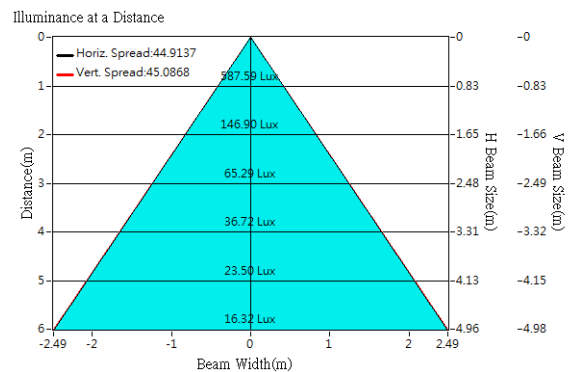

H: -0.5 mm



Optical Characteristics

Model Number	CKO-ZU15-034009-9803
LED	CXB1304
LES / LED Size	Φ 6 mm
FWHM (D50)	21°-40°
Field Angle (D10)	45°-75°
H (distance)	2.0mm~0.5mm
Dimension	Φ =34 mm, Thickness=8.2 mm
Luminous Flux	433 lm ~ 444 lm (21° ~ 40°) Measured @ 3.5 W
Material	PC / UL94V2

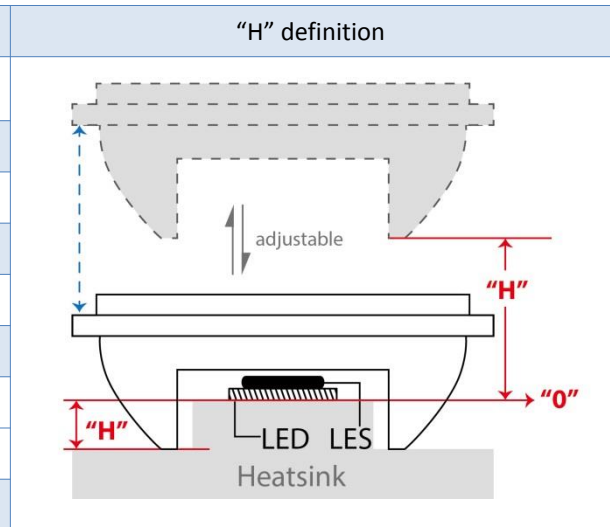

cd/klm

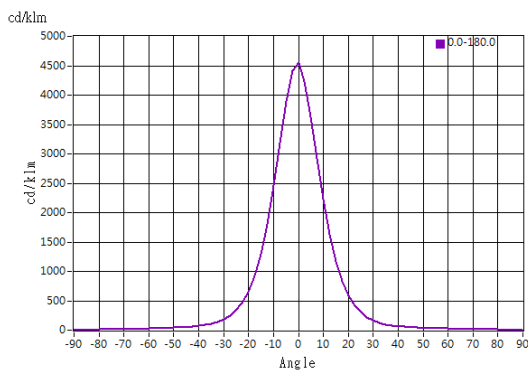

H: 2.0 mm

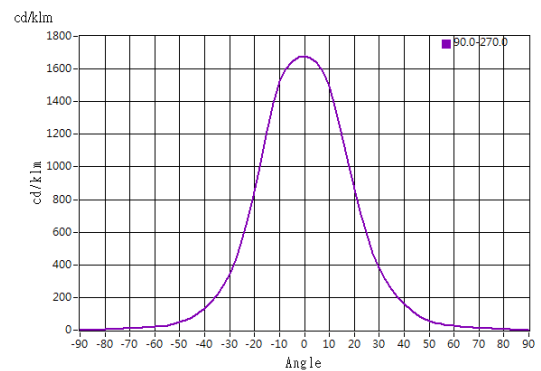

H: -0.5 mm

Illuminance At Distances

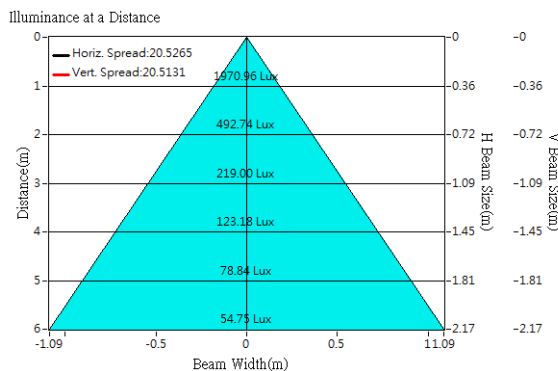

H: 2.0 mm

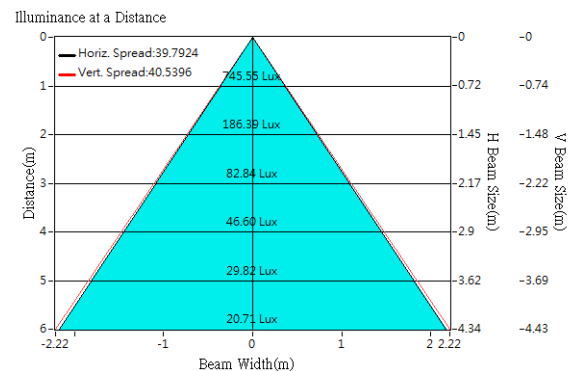

H: -0.5 mm