



Product Model Number

CKO-ZU15-034009-9803

✓ Model Number Definitions

CKO-XXXX-XXXXXX-XXXX



- A. Chun Kuang Optics Corp. Product
- B. Product Type: product abbreviation
Ex:
CH→CoB High Intensity
CC→CoB Compact
ZU→Multi-Angle Zooming Lens
HC→Holder for CoB LED

- C. Identity Code
- D. Lens / Fixture Size
Ex: 075026=Φ75mm / Thickness=26mm (round up)
- E. Serial Numbers

The lens datasheet is applicable for **Luminus LED**, that manufactured by Chun Kuang Optics Corp.

✓ Dimensions (mm) : Φ34 x 8.2

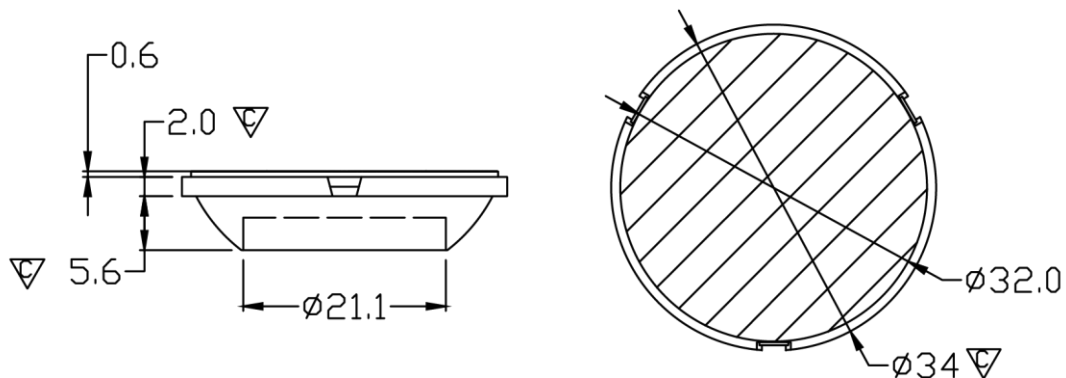

▽:Critical Dimension



Optical Characteristics

Model Number	CKO-ZU15-034009-9803
LED	CXM-4-30-90-36-AC40
LES / LED Size	Φ 4.5 mm
FWHM (D50)	17°-33°
Field Angle (D10)	39°-62°
H (distance)	1.5mm~-0.5mm
Dimension	Φ =34 mm, Thickness=8.2 mm
Luminous Flux	461 lm ~ 471 lm (22° ~ 39°) Measured @ 4 W
Material	PC / UL94V2

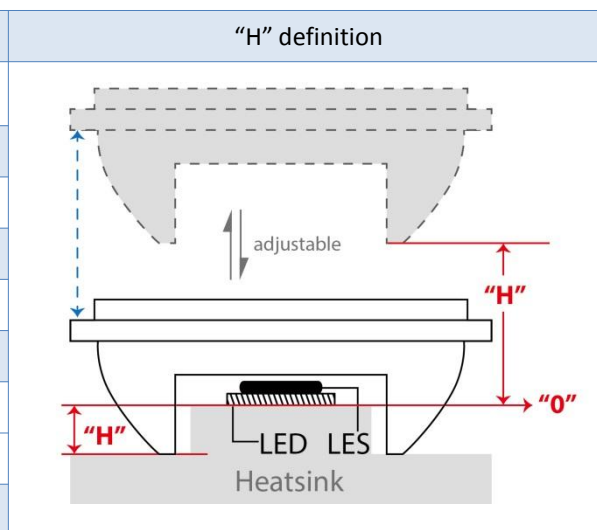

cd/klm

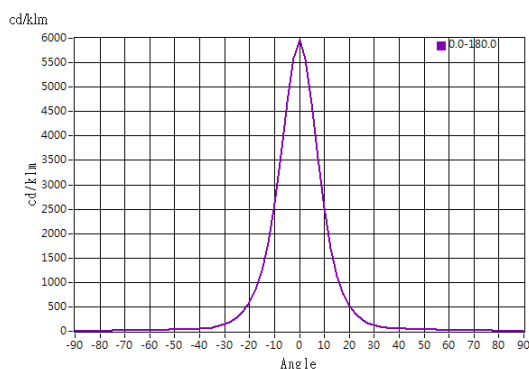

H: 1.5 mm

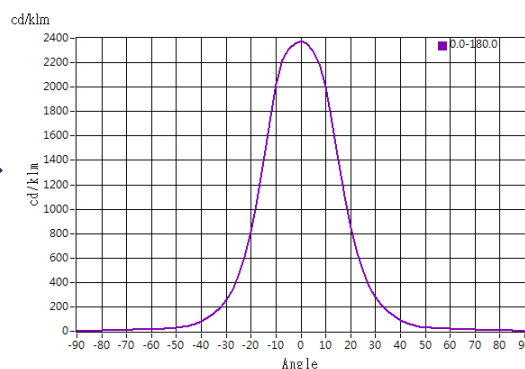

H: -0.5 mm

Illuminance At Distances

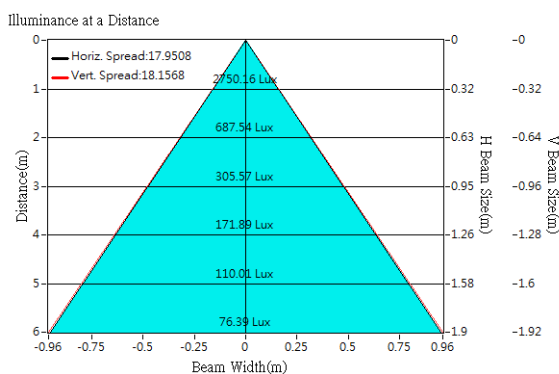

H: 1.5 mm

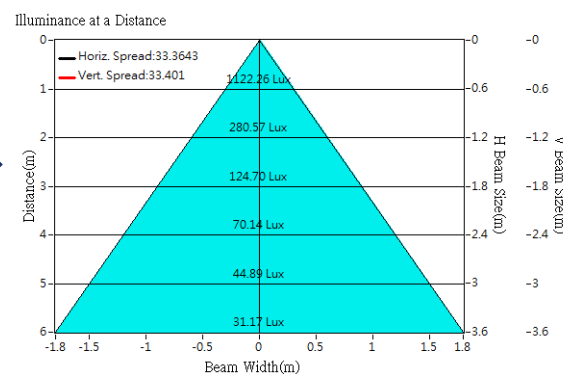

H: -0.5 mm



Optical Characteristics

Model Number	CKO-ZU15-034009-9803
LED	CXM-6-AC40
LES / LED Size	Φ 6.3 mm
FWHM (D50)	23°-39°
Field Angle (D10)	51°-78°
H (distance)	1.55mm~0.5mm
Dimension	Φ =34 mm, Thickness=8.2 mm
Luminous Flux	740 lm ~ 762 lm (23°-39°) Measured @ 5.2 W
Material	PC / UL94V2

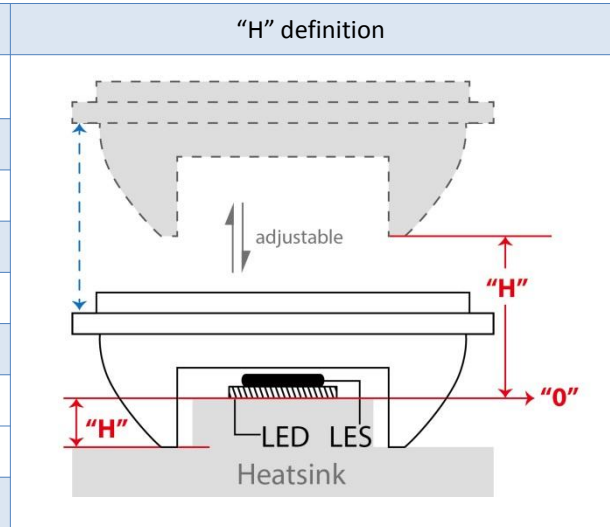

cd/klm

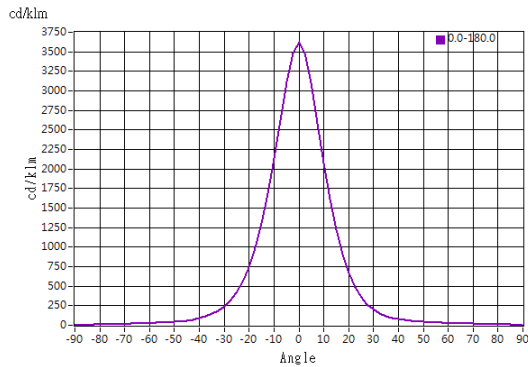

H: 1.55 mm

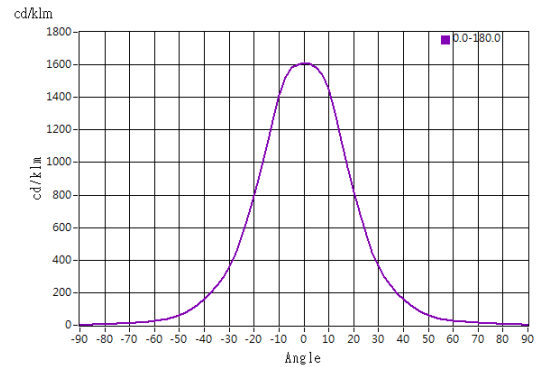

H: -0.5 mm

Illuminance At Distances

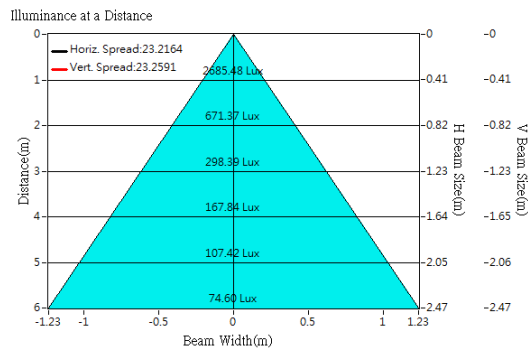

H: 1.55 mm

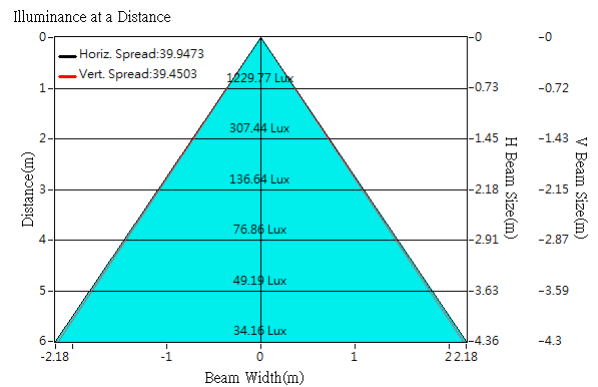

H: -0.5 mm



Optical Characteristics

Model Number	CKO-ZU15-034009-9803
LED	CXM-9-30-90-36-AC30
LES / LED Size	Φ 9.6 mm
FWHM (D50)	30°-45°
Field Angle (D10)	68°-100°
H (distance)	1.55mm~-0.5mm
Dimension	Φ =34 mm, Thickness=8.2 mm
Luminous Flux	1374 lm ~ 1405 lm (30° ~ 45°) Measured @ 12.5 W
Material	PC / UL94V2

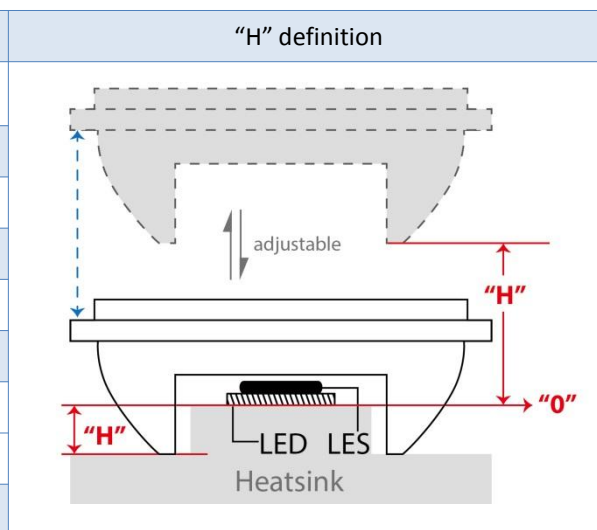

cd/klm

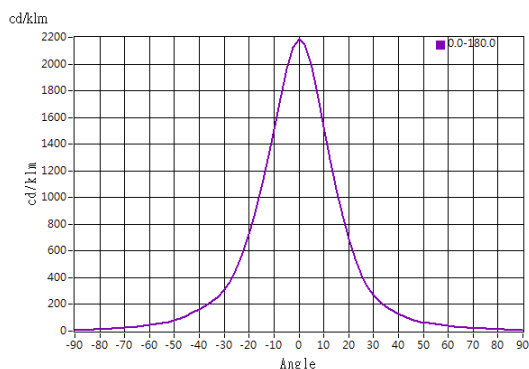

H: 1.55 mm

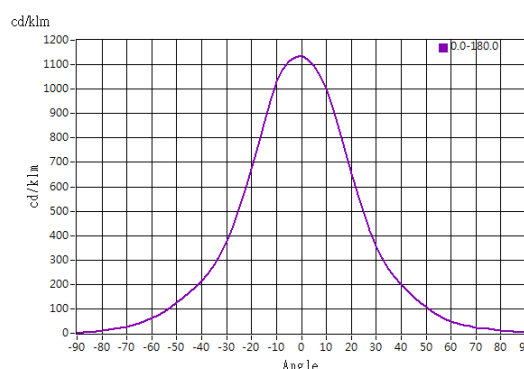

H: -0.5 mm

Illuminance At Distances

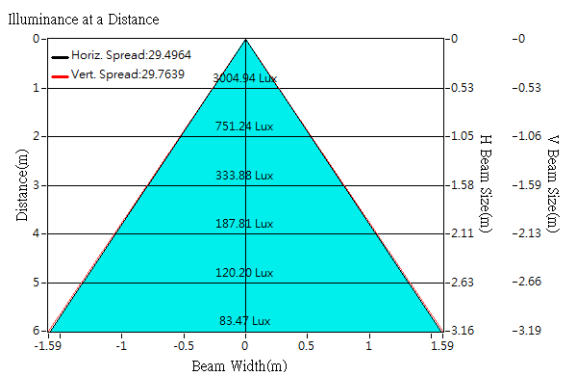

H: 1.55 mm

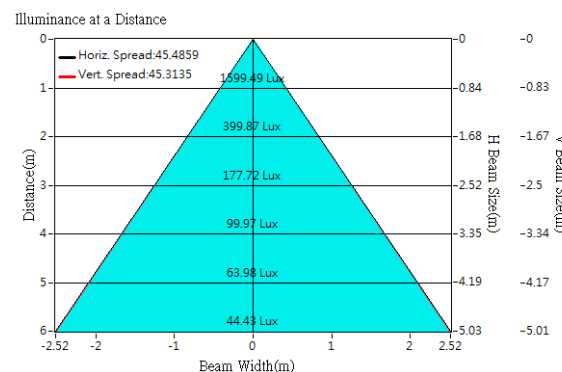

H: -0.5 mm



Optical Characteristics

Model Number	CKO-ZU15-034009-9803
LED	CXM-9-30-90-36-AC40
LES / LED Size	Φ 9.8 mm
FWHM (D50)	31°-41°
Field Angle (D10)	75°-95°
H (distance)	1.0mm~-0.5mm
Dimension	Φ =34 mm, Thickness=8.2 mm
Luminous Flux	1538 lm ~ 1554 lm (31° ~ 41°) Measured @ 12 W
Material	PC / UL94V2

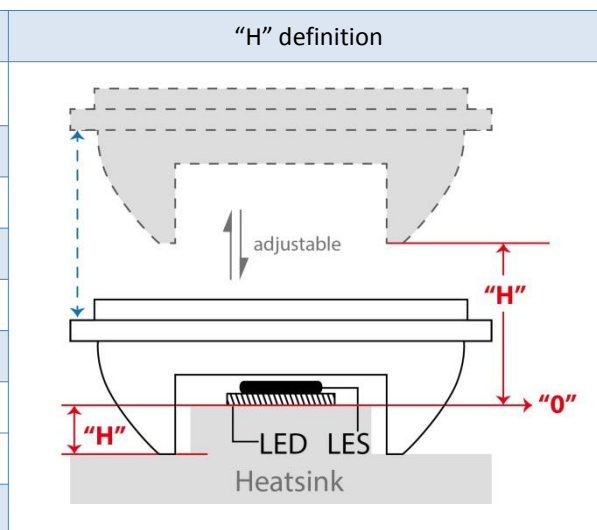

cd/klm

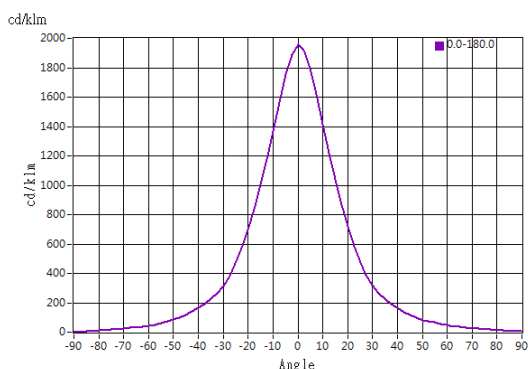

H: 1.0 mm

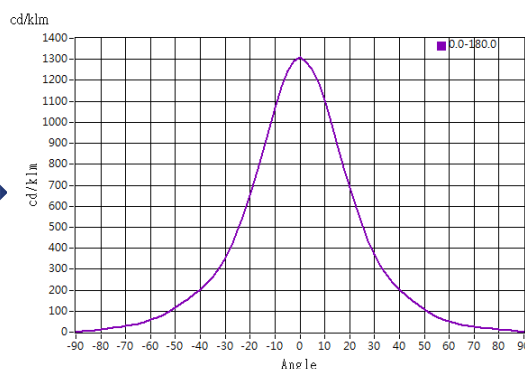

H: -0.5 mm

Illuminance At Distances

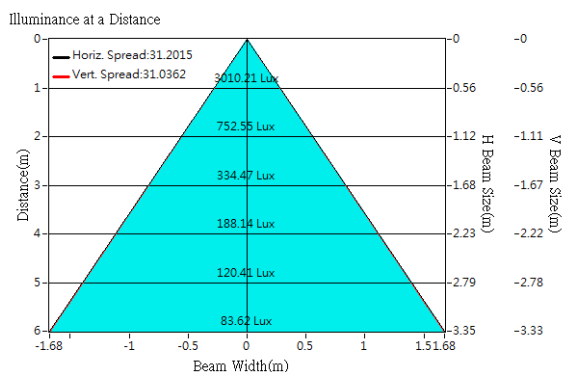

H: 1.0 mm

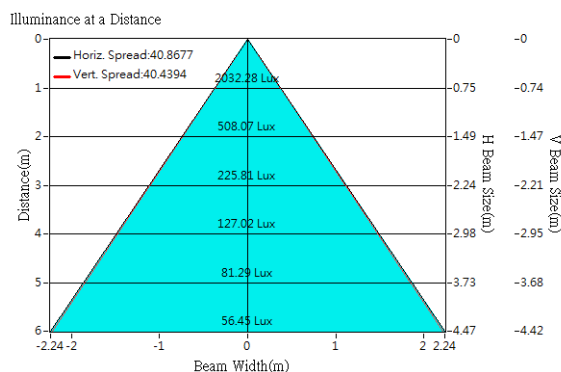

H: -0.5 mm