



## Product Model Number

**CKO-ZU15-045011-9501**

### ✓ Model Number Definitions

**CKO-XXXX-XXXXXX-XXXX**



- A. Chun Kuang Optics Corp. Product
- B. Product Type: product abbreviation  
Ex:  
CH→CoB High Intensity  
CC→CoB Compact  
ZU→Multi-Angle Zooming Lens  
HC→Holder for CoB LED

- C. Identity Code
- D. Lens / Fixture Size  
Ex: 075026=Φ75mm / Thickness=26mm (round up)
- C. Serial Numbers

The lens datasheet is applicable for **Philips LED**, that manufactured by Chun Kuang Optics Corp.

### ✓ Dimensions (mm) : Φ45 x 11.6

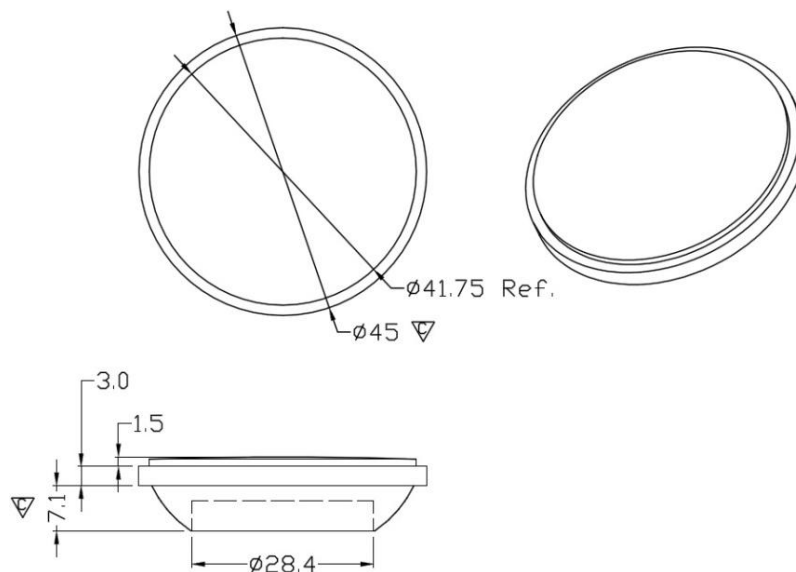

▽:Critical Dimension





## Optical Characteristics

Model Number	CKO-ZU15-045011-9501
LED	<b>Fortimo SLM 1202 L06 G7</b>
LES / LED Size	Φ 6.5 mm
FWHM (D50)	18°-41°
Field Angle (D10)	42°-76°
H (distance)	1.7mm~-1.6mm
Dimension	Φ =45 mm, Thickness=11.6 mm
Luminous Flux	1449 lm ~ 1476 lm (18° ~ 41°) Measured @ 13.2 W
Material	PC / UL94V2

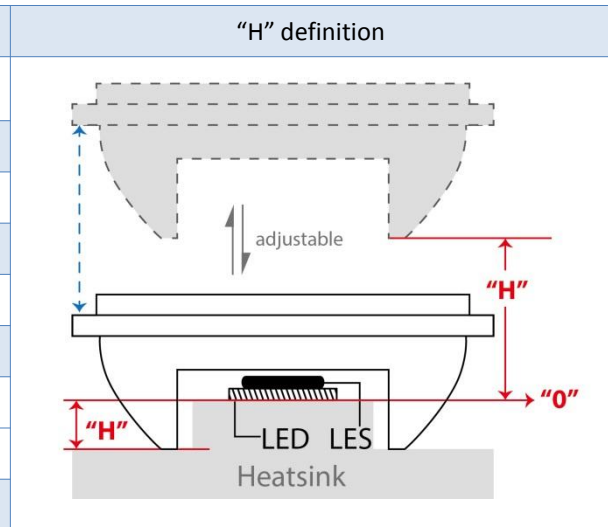

## cd/klm

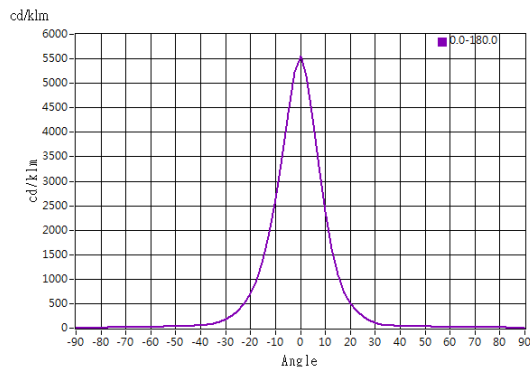

H: 1.7 mm

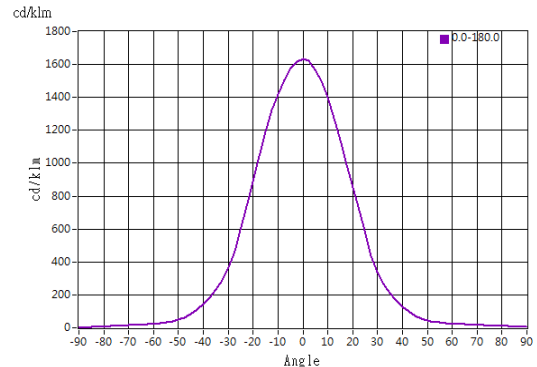

H: -1.6 mm

## Illuminance At Distances

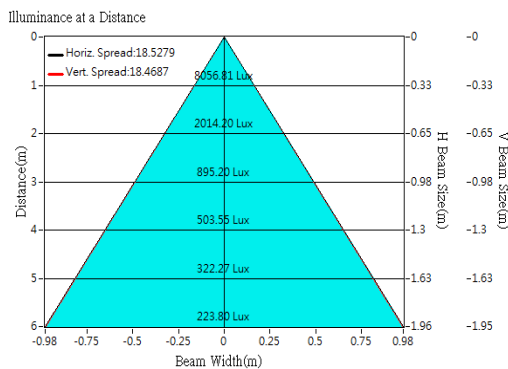

H: 1.7 mm

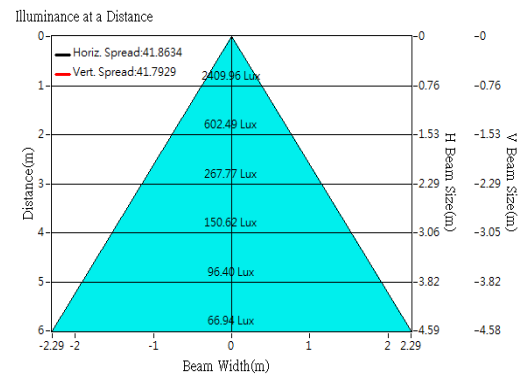

H: -1.6 mm



## Optical Characteristics

Model Number	CKO-ZU15-045011-9501
LED	<b>Fortimo SLM 1203 L09 G6</b>
LES / LED Size	Φ 9 mm
FWHM (D50)	23°-47°
Field Angle (D10)	51°-88°
H (distance)	1.7mm~-1.6mm
Dimension	Φ =45 mm, Thickness=11.6 mm
Luminous Flux	1340 lm ~ 1385 lm (23° ~ 47°) Measured @ 10.4 W
Material	PC / UL94V2

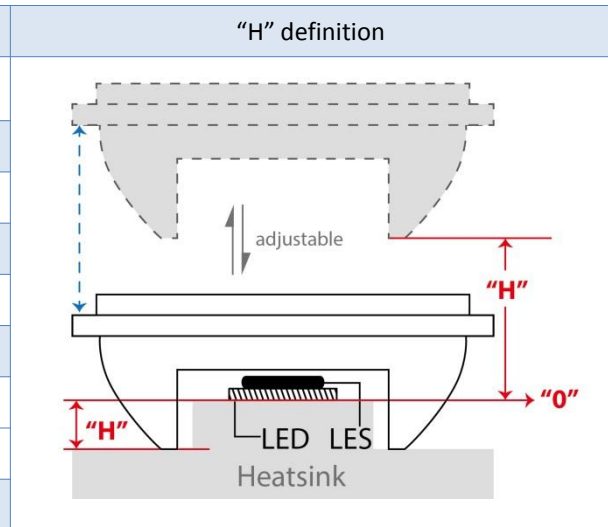

## cd/klm

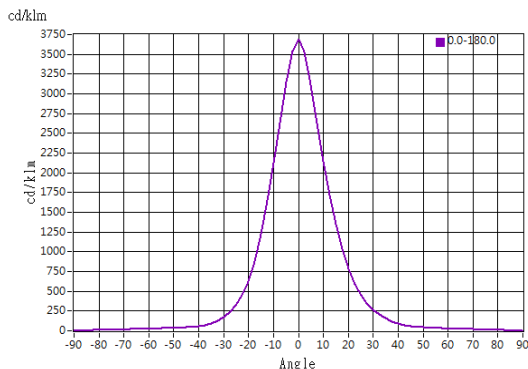

H: 1.7 mm

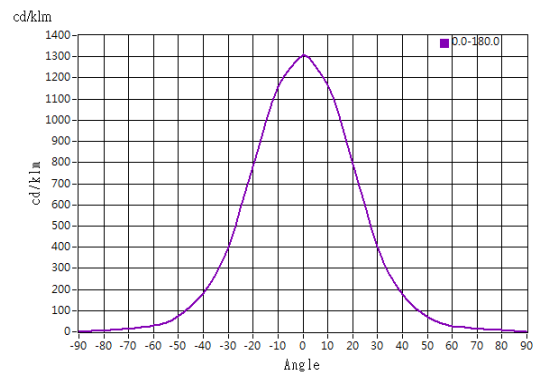

H: -1.6 mm

## Illuminance At Distances

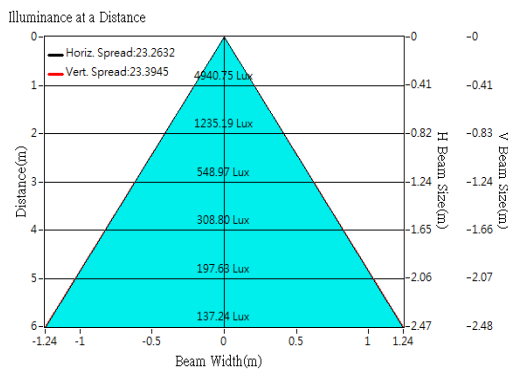

H: 1.7 mm

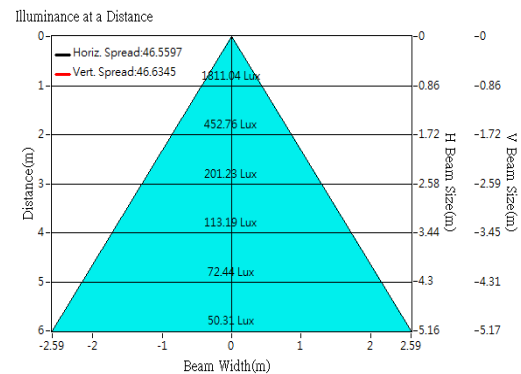

H: -1.6 mm



## Optical Characteristics

Model Number	CKO-ZU15-045011-9501
LED	<b>Fortimo SLM 1204 L09 G7</b>
LES / LED Size	Φ 9 mm
FWHM (D50)	23°-48°
Field Angle (D10)	50°-89°
H (distance)	1.7mm~1.8mm
Dimension	Φ =45 mm, Thickness=11.6 mm
Luminous Flux	2211 lm ~ 2272 lm (23° ~ 48°) Measured @ 22.4 W
Material	PC / UL94V2

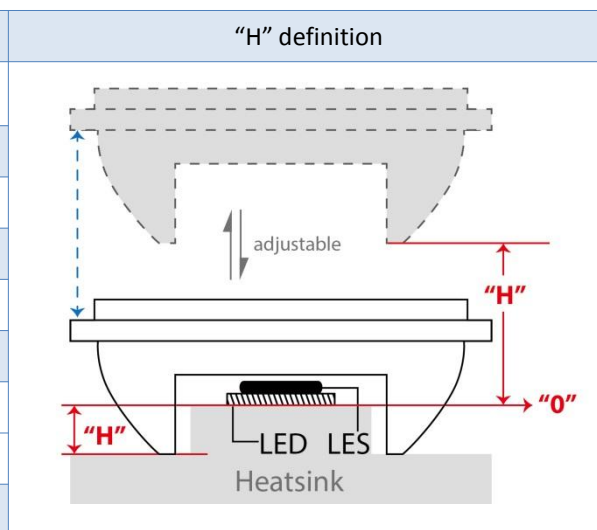

## cd/klm

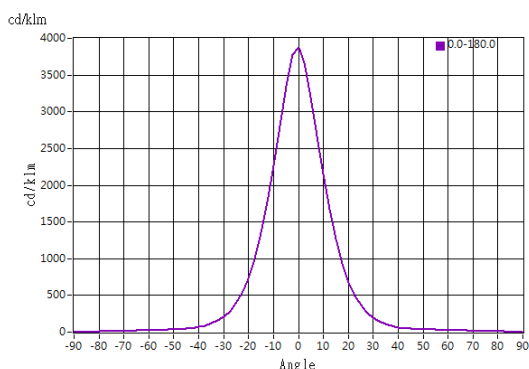

**H: 1.7 mm**

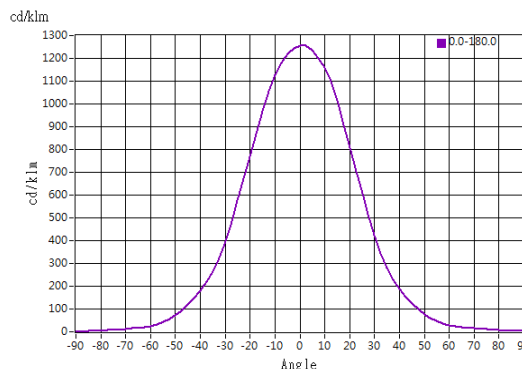

**H: -1.8 mm**

## Illuminance At Distances

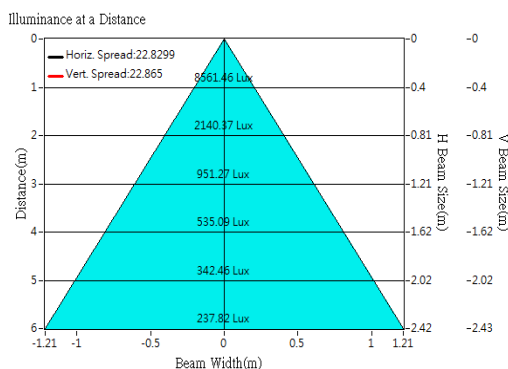

**H: 1.7 mm**

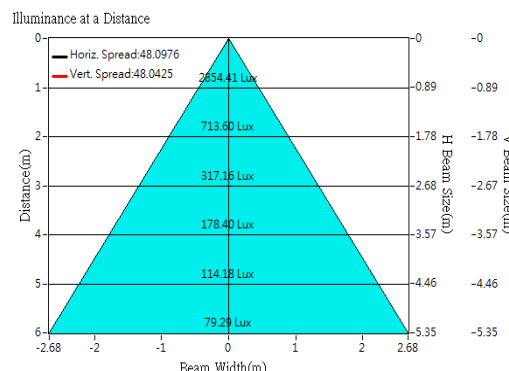

**H: -1.8 mm**