



## Product Model Number

**CKO-ZU15-060013-9401**

### ✓ Model Number Definitions

**CKO-XXXX-XXXXXX-XXXX**



- A. Chun Kuang Optics Corp. Product
- B. Product Type: product abbreviation  
Ex:  
CH→CoB High Intensity  
CC→CoB Compact  
ZU→Multi-Angle Zooming Lens  
HC→Holder for CoB LED

- C. Identity Code
- D. Lens / Fixture Size  
Ex: 075026=Φ75mm / Thickness=26mm (round up)
- C. Serial Numbers

The lens datasheet is applicable for **Luminus LED**, that manufactured by Chun Kuang Optics Corp.

### ✓ Dimensions (mm) : Φ60 x 13

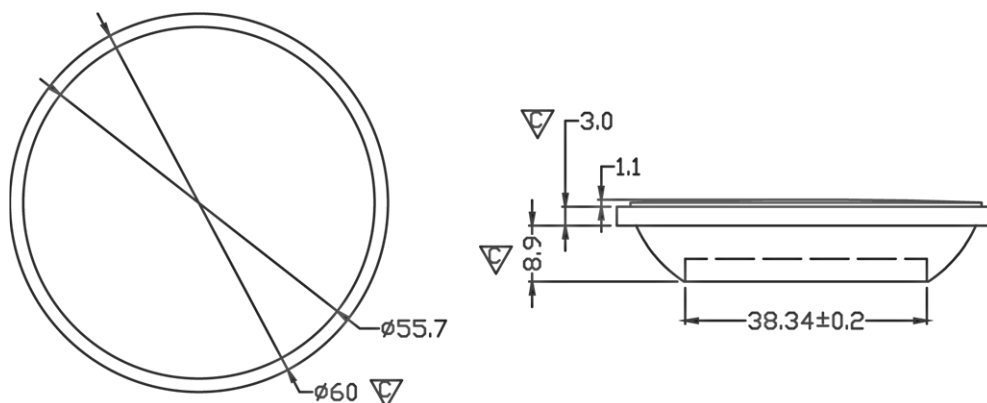

▽:Critical Dimension





## Optical Characteristics

|                   |   |
|-------------------|---|
| Model Number      | CKO-ZU15-060013-9401                            |
| LED               | <b>CXM-6-30-80-36-AC40</b>                      |
| LES / LED Size    | Φ 6.3 mm  |
| FWHM (D50)        | 15°-29°   |
| Field Angle (D10) | 35°-64°   |
| H (distance)      | 2.2mm~0.8mm                                     |
| Dimension         | Φ =60 mm, Thickness=13 mm                       |
| Luminous Flux     | 759 lm ~ 782 lm (15° ~ 29°)<br>Measured @ 5.1 W |
| Material          | PC / UL94V2                                     |

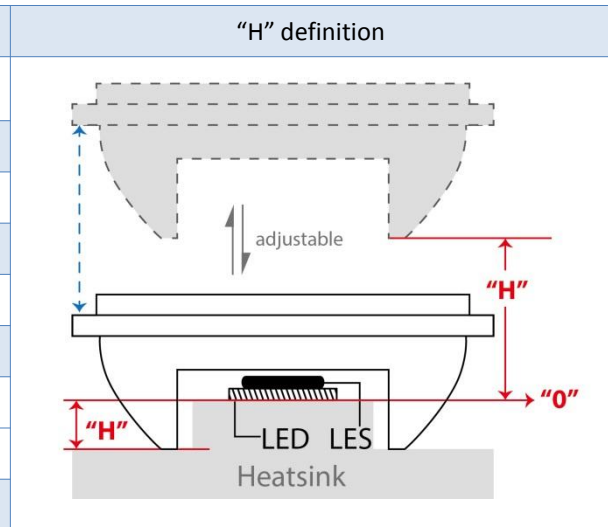

## cd/klm

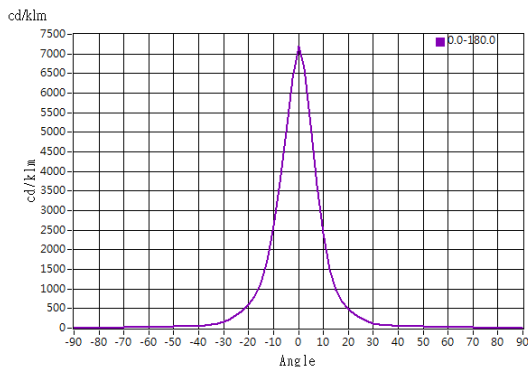

H: 2.2 mm

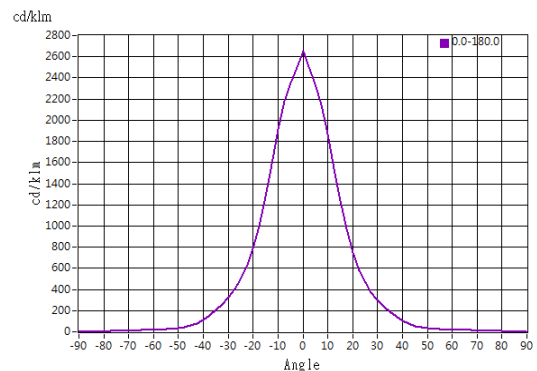

H: -0.8 mm

## Illuminance At Distances

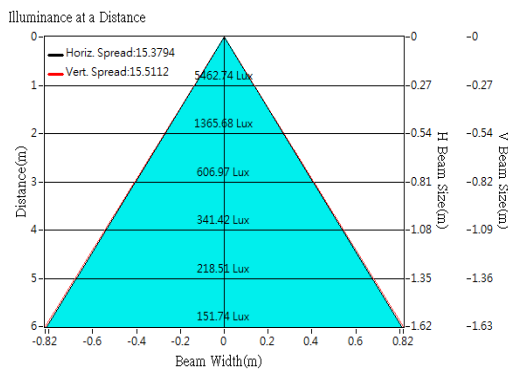

H: 2.2 mm

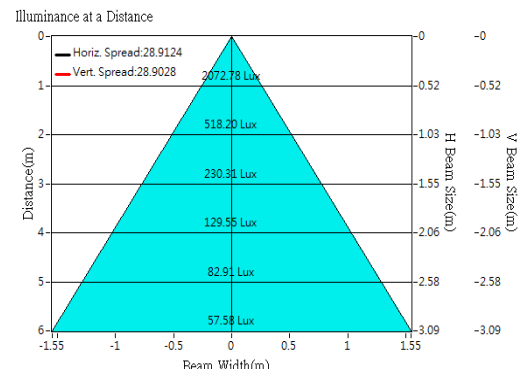

H: -0.8 mm



## Optical Characteristics

|                   |  |
|-------------------|--|
| Model Number      | CKO-ZU15-060013-9401                               |
| LED               | <b>CXM-9-30-90-36-AC40</b>                         |
| LES / LED Size    | Φ 9.8 mm   |
| FWHM (D50)        | 21°-38°  |
| Field Angle (D10) | 46°-82°  |
| H (distance)      | 2.0mm~1.6mm  |
| Dimension         | Φ =60 mm, Thickness=13 mm                          |
| Luminous Flux     | 1518 lm ~ 1540 lm (21° ~ 38°)<br>Measured @ 12.4 W |
| Material          | PC / UL94V2  |

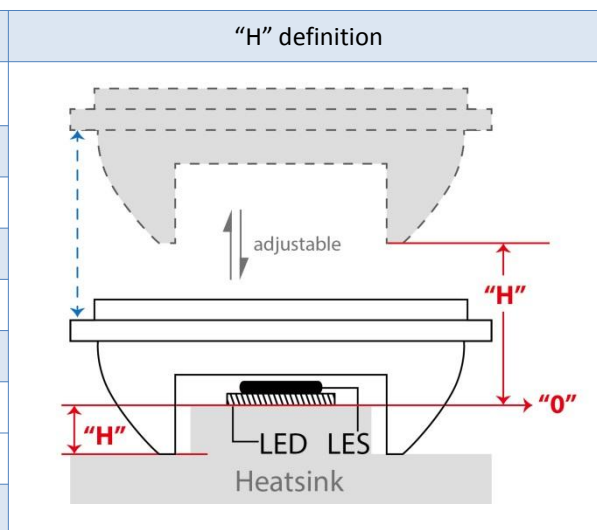

## cd/klm

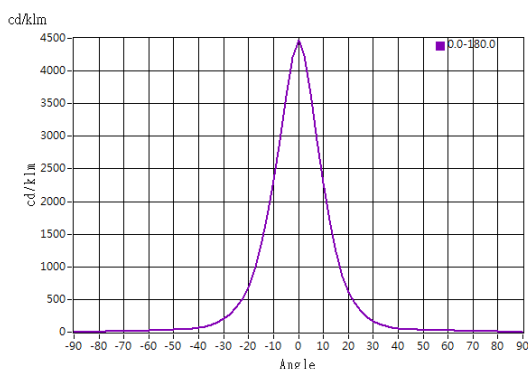

**H: 2.0 mm**

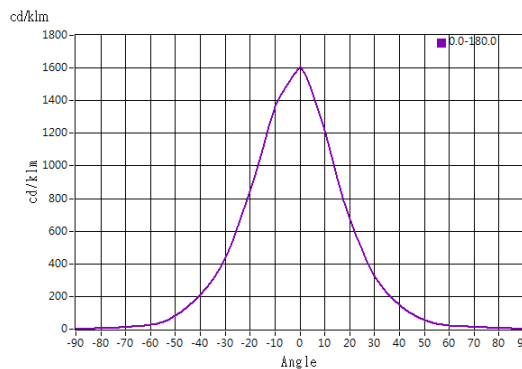

**H: -1.6 mm**

## Illuminance At Distances

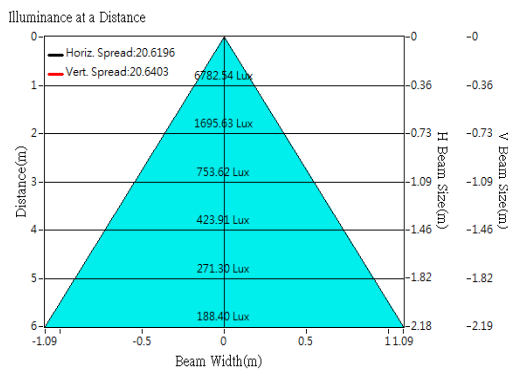

**H: 2.0 mm**

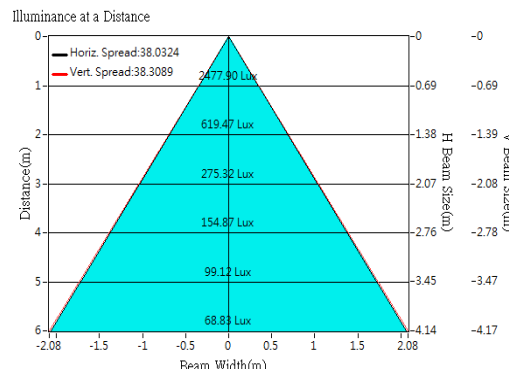

**H: -1.6 mm**



## Optical Characteristics

|                   |  |
|-------------------|--|
| Model Number      | CKO-ZU15-060013-9401                             |
| LED               | <b>CLM-14-AC40</b>                               |
| LES / LED Size    | Φ 14.5 mm  |
| FWHM (D50)        | 29°-44°  |
| Field Angle (D10) | 66°-102°   |
| H (distance)      | 2.5mm~1.8mm                                      |
| Dimension         | Φ =60 mm, Thickness=13 mm                        |
| Luminous Flux     | 2553 lm ~ 2616 lm (29°-44°)<br>Measured @ 17.2 W |
| Material          | PC / UL94V2                                      |

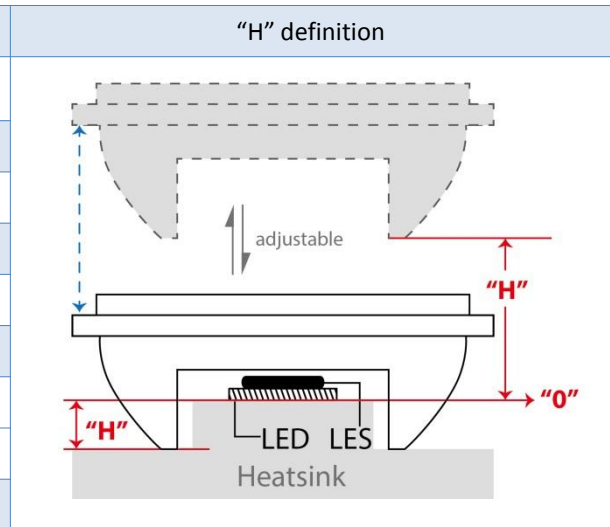

## cd/klm

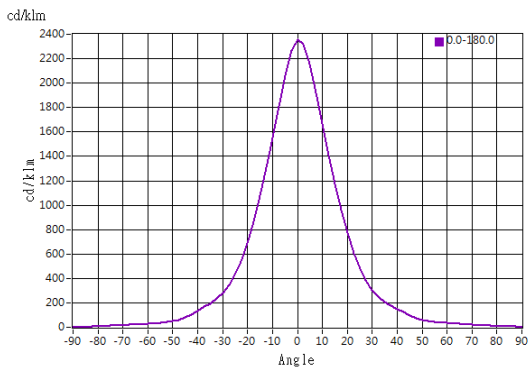

H: 2.5 mm

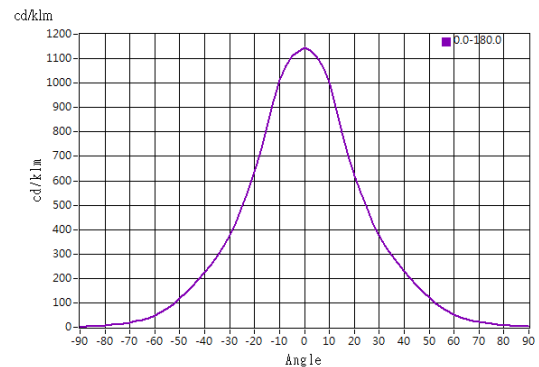

H: -1.8 mm

## Illuminance At Distances

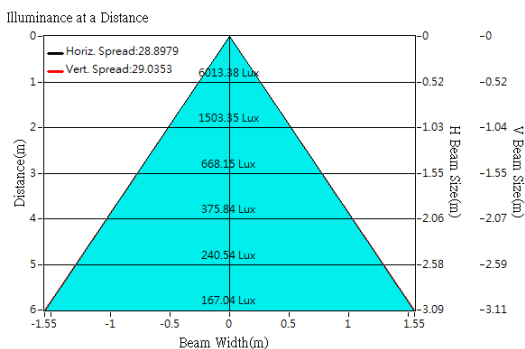

H: 2.5 mm

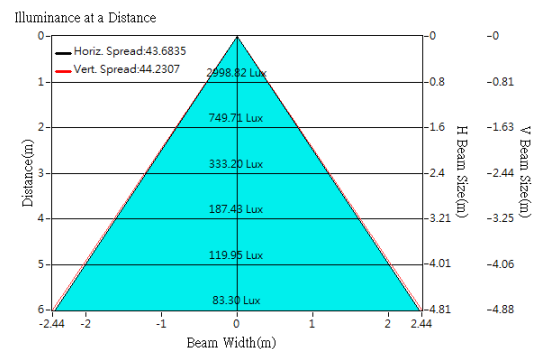

H: -1.8 mm