



Product Model Number

CKO-ZU15-092020-9601

✓ Model Number Definitions

CKO-XXXX-XXXXXX-XXXX



- A. Chun Kuang Optics Corp. Product
- B. Product Type: product abbreviation
Ex:
CH→CoB High Intensity
CC→CoB Compact
ZU→Multi-Angle Zooming Lens
HC→Holder for CoB LED

- C. Identity Code
- D. Lens / Fixture Size
Ex: 075026=Φ75mm / Thickness=26mm (round up)
- C. Serial Numbers

The lens datasheet is applicable for **Philips LED**, that manufactured by Chun Kuang Optics Corp.

✓ Dimensions (mm) : Φ92 x 19.5

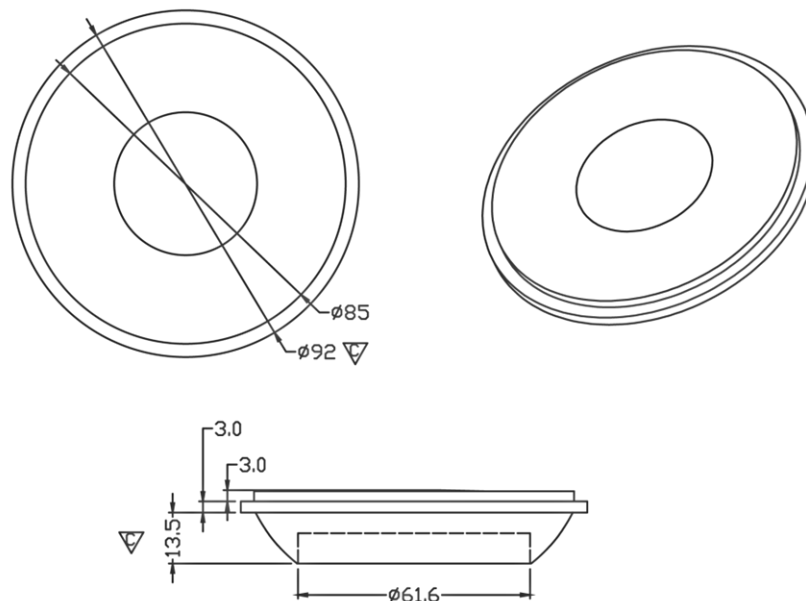

▽:Critical Dimension



Optical Characteristics

Model Number	CKO-ZU15-092020-9601
LED	Fortimo SLM 1205 L13 G6
LES / LED Size	Φ 13 mm
FWHM (D50)	16°-29°
Field Angle (D10)	37°-57°
H (distance)	4.5mm~0mm
Dimension	Φ =92 mm, Thickness=19.5 mm
Luminous Flux	2301 lm ~ 2340 lm (16° ~ 29°) Measured @ 18 W
Material	PC / UL94V2

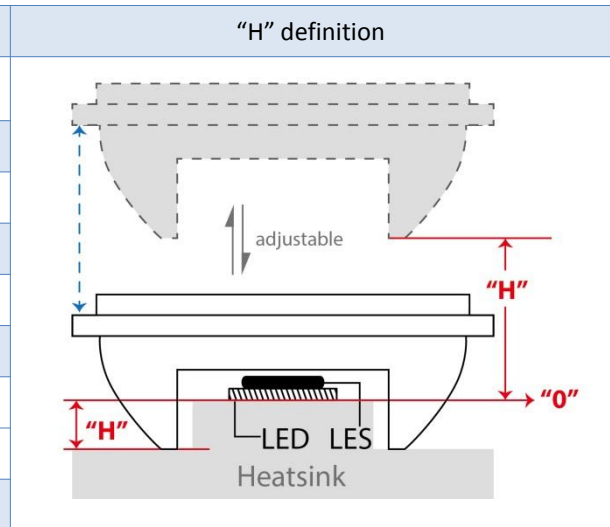

cd/klm

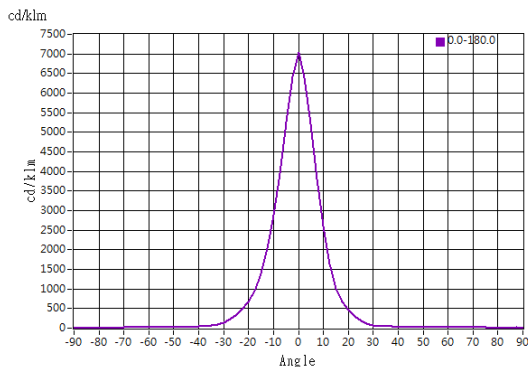

H: 4.5 mm

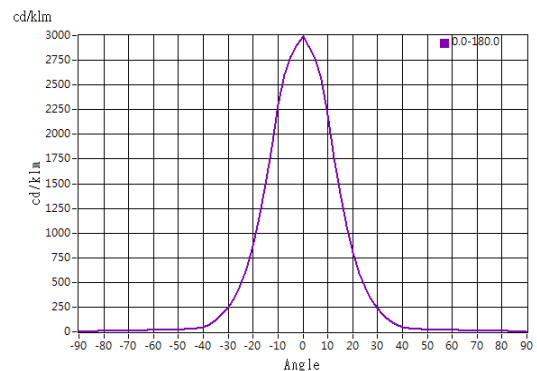

H: 0 mm

Illuminance At Distances

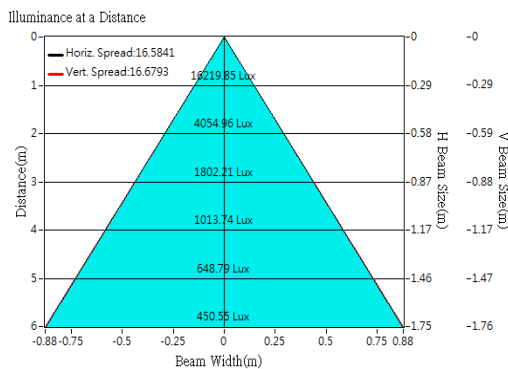

H: 4.5 mm

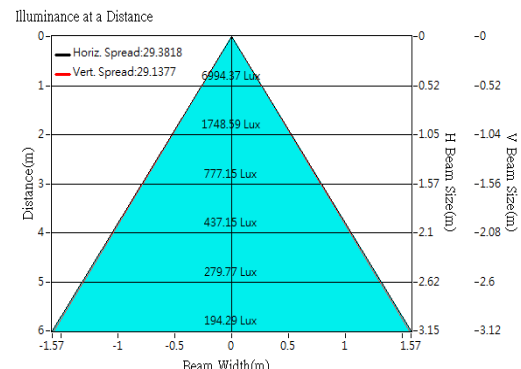

H: 0 mm



Optical Characteristics

Model Number	CKO-ZU15-092020-9601
LED	Fortimo SLM 1205 L13 G7
LES / LED Size	Φ 13 mm
FWHM (D50)	16°-31°
Field Angle (D10)	37°-61°
H (distance)	4.5mm~0mm
Dimension	Φ =92 mm, Thickness=19.5 mm
Luminous Flux	2441 lm ~ 2489 lm (16° ~ 31°) Measured @ 17.8 W
Material	PC / UL94V2

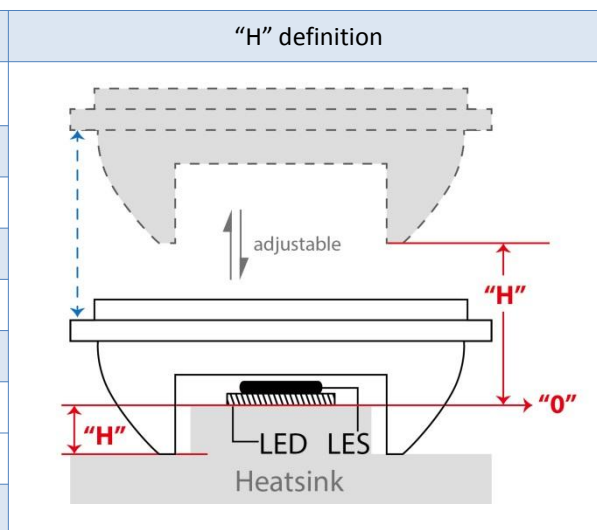

cd/klm

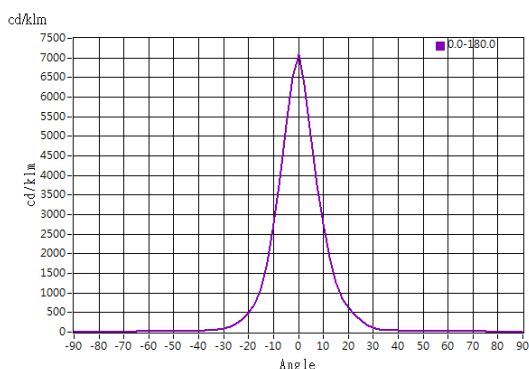

H: 4.5 mm

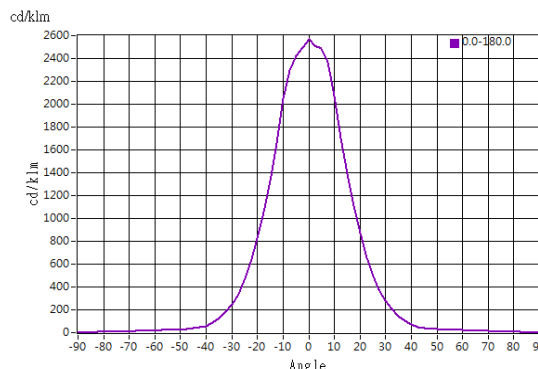

H: 0 mm

Illuminance At Distances

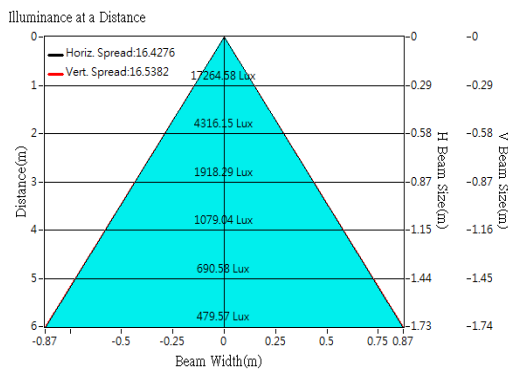

H: 4.5 mm

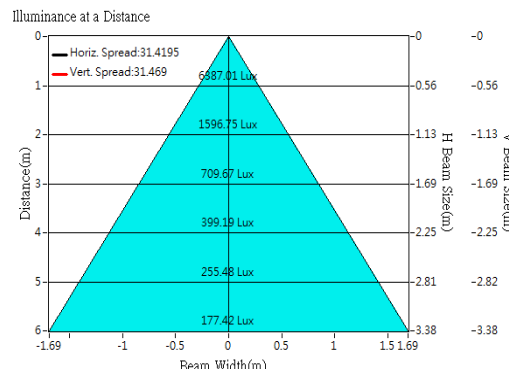

H: 0 mm



Optical Characteristics

Model Number	CKO-ZU15-092020-9601
LED	Fortimo SLM 1208 L15 G6
LES / LED Size	Φ 15 mm
FWHM (D50)	17°-39°
Field Angle (D10)	40°-70°
H (distance)	4.0mm~1.0mm
Dimension	Φ =92 mm, Thickness=19.5 mm
Luminous Flux	2665 lm ~ 2653 lm (17° ~ 39°) Measured @ 26.3 W
Material	PC / UL94V2

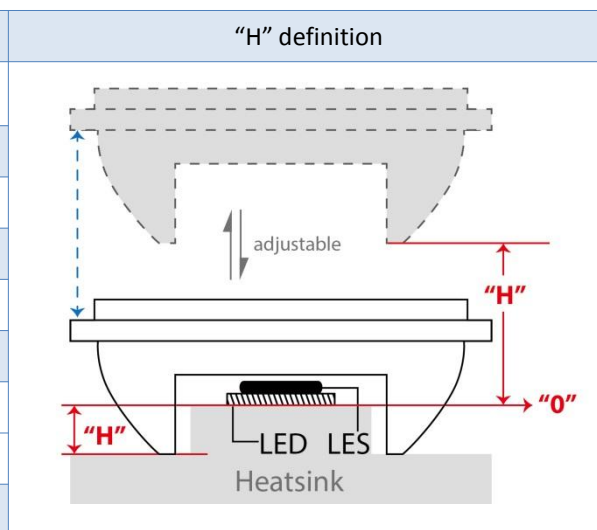

cd/klm

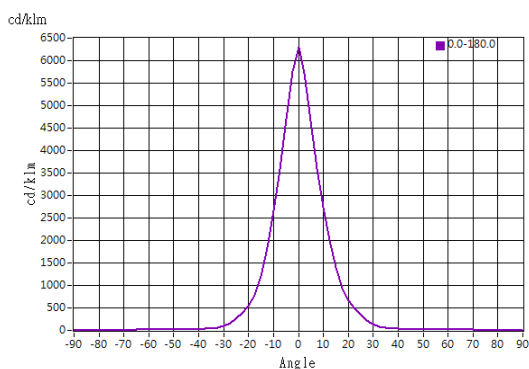

H: 4.0 mm

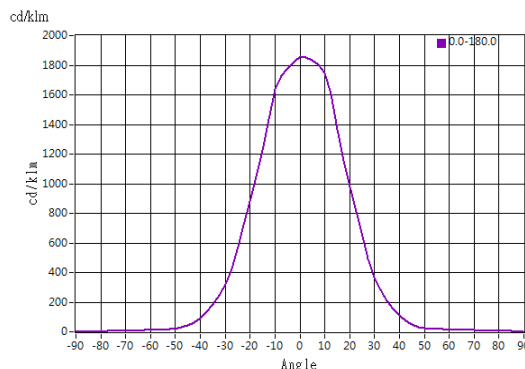

H: -1.0 mm

Illuminance At Distances

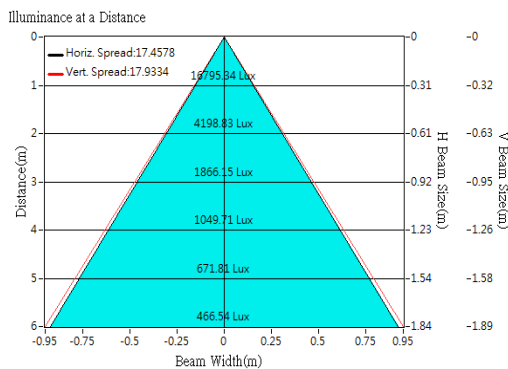

H: 4.0 mm

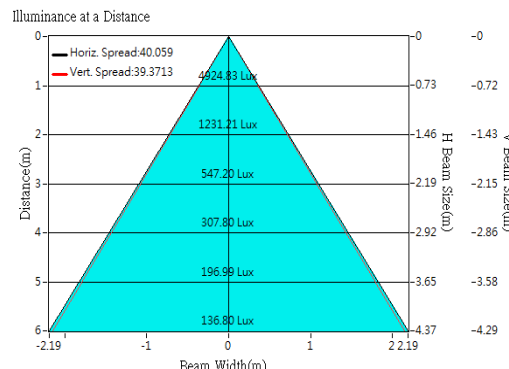

H: -1.0 mm



Optical Characteristics

Model Number	CKO-ZU15-092020-9601
LED	Fortimo SLM 1208 L15 G7
LES / LED Size	Φ 15 mm
FWHM (D50)	17°-31°
Field Angle (D10)	38°-61°
H (distance)	5.0mm~ 0mm
Dimension	Φ =92 mm, Thickness=19.5 mm
Luminous Flux	3151 lm ~ 3203 lm (17° ~ 31°) Measured @ 26.3 W
Material	PC / UL94V2

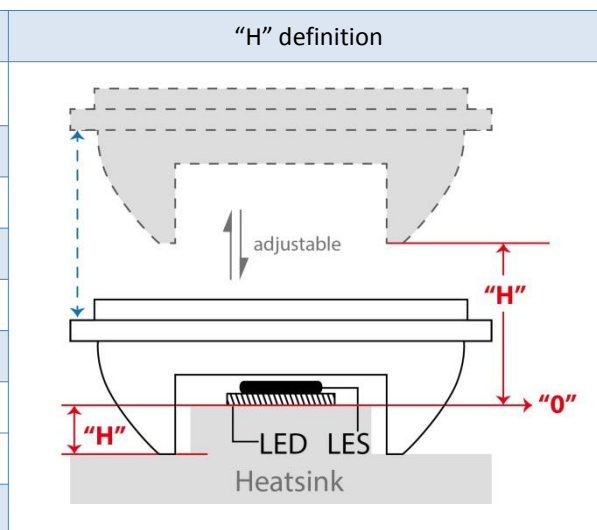

cd/klm

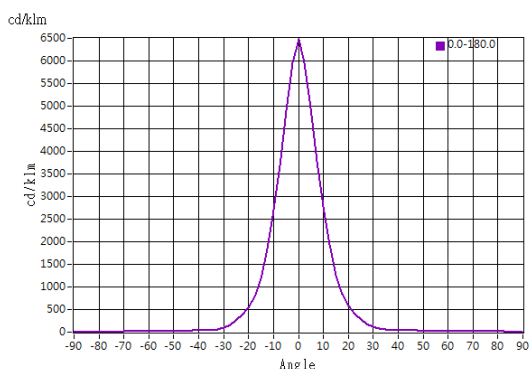

H: 5.0 mm

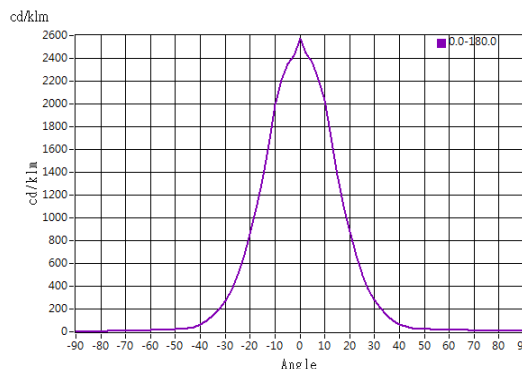

H: 0 mm

Illuminance At Distances

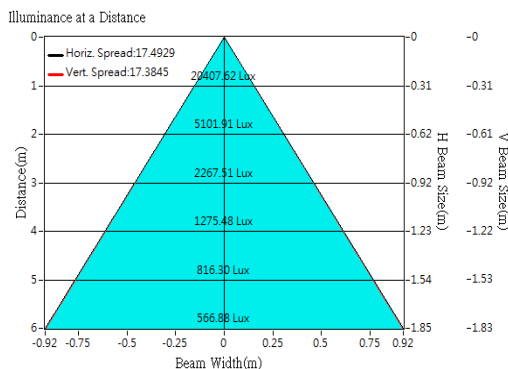

H: 5.0 mm

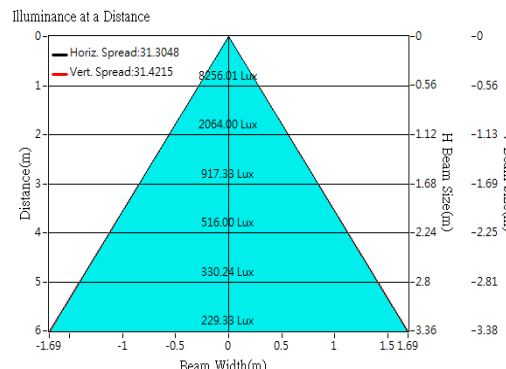

H: 0 mm



Optical Characteristics

Model Number	CKO-ZU15-092020-9601
LED	Fortimo SLM 1211 L19 G6
LES / LED Size	Φ 19 mm
FWHM (D50)	21°-53°
Field Angle (D10)	47°-93°
H (distance)	4mm~4.0mm
Dimension	Φ =92 mm, Thickness=19.5 mm
Luminous Flux	2674 lm ~ 5434 lm (21° ~ 53°) Measured @ 44.2 W
Material	PC / UL94V2

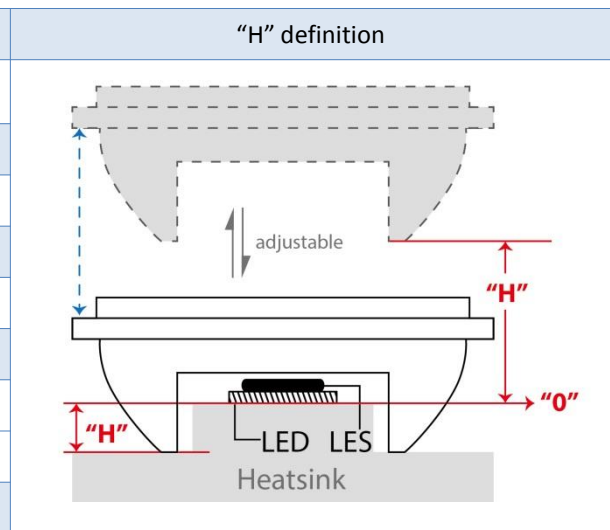

cd/klm

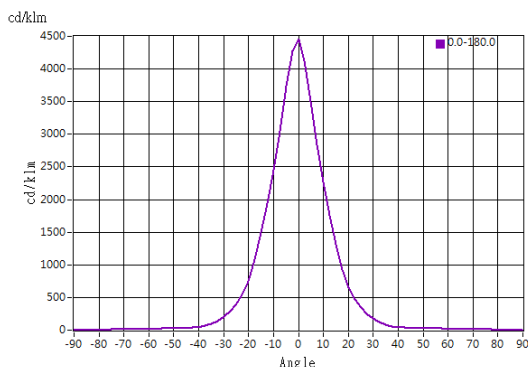

H: 4 mm

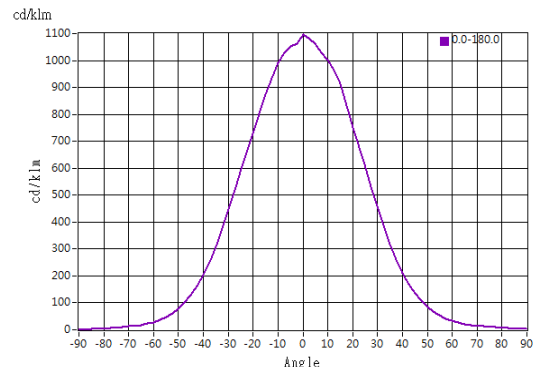

H: -4 mm

Illuminance At Distances

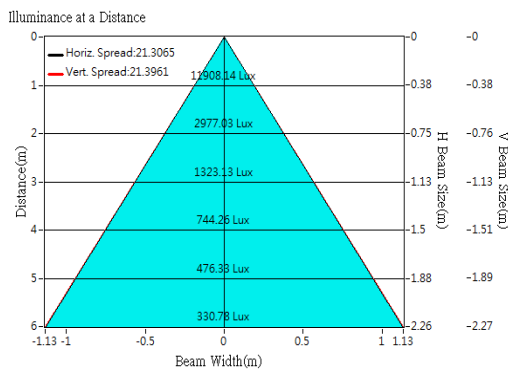

H: 4 mm

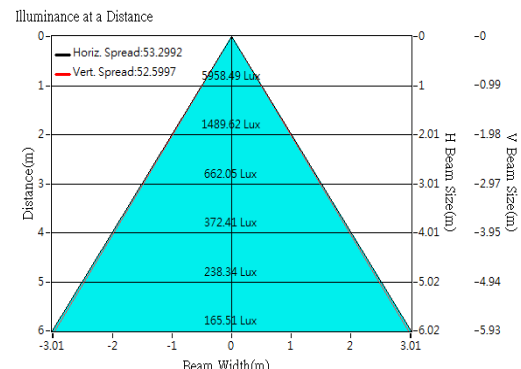

H: -4 mm