



Product Model Number

CKO-ZU15-110025-9301

✓ Model Number Definitions

CKO-XXXX-XXXXXX-XXXX



- A. Chun Kuang Optics Corp. Product
- B. Product Type: product abbreviation
Ex:
CH→CoB High Intensity
CC→CoB Compact
ZU→Multi-Angle Zooming Lens
HC→Holder for CoB LED

- C. Identity Code
- D. Lens / Fixture Size
Ex: 075026=Φ75mm / Thickness=26mm (round up)
- C. Serial Numbers

The lens datasheet is applicable for **Philips LED**, that manufactured by Chun Kuang Optics Corp.

✓ Dimensions (mm) : Φ110 x 24.5

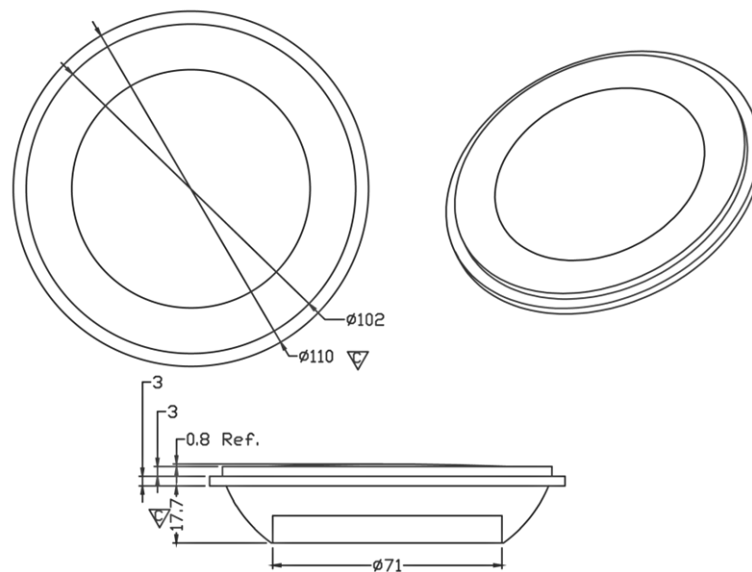

▽:Critical Dimension



Optical Characteristics

Model Number	CKO-ZU15-110025-9301
LED	Fortimo SLM 1208 L15 G6
LES / LED Size	Φ 15 mm
FWHM (D50)	15°-33°
Field Angle (D10)	38°-64°
H (distance)	6.0mm~1.5mm
Dimension	Φ =110 mm, Thickness=24.5 mm
Luminous Flux	2463 lm ~ 2554 lm (15° ~ 33°) Measured @ 26.1 W
Material	PC / UL94V2

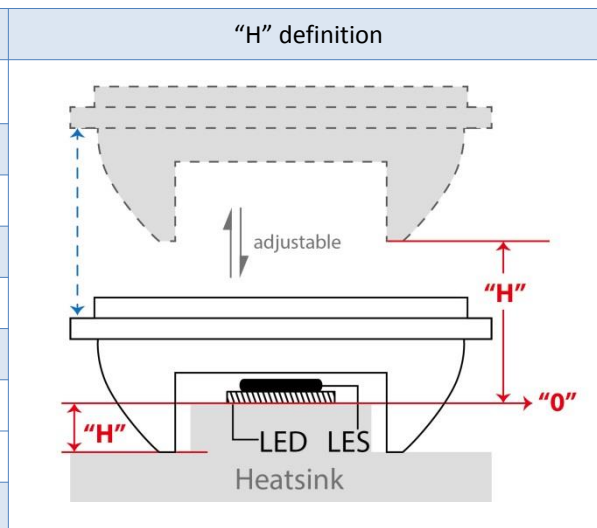

cd/klm

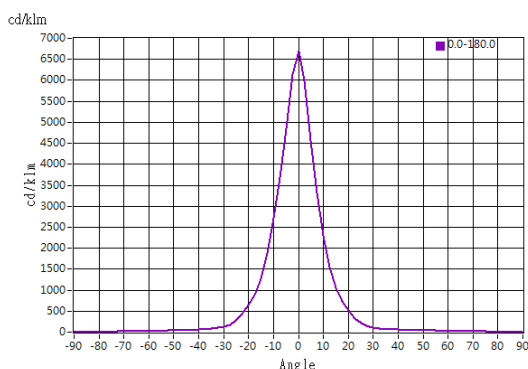

H: 6.0 mm

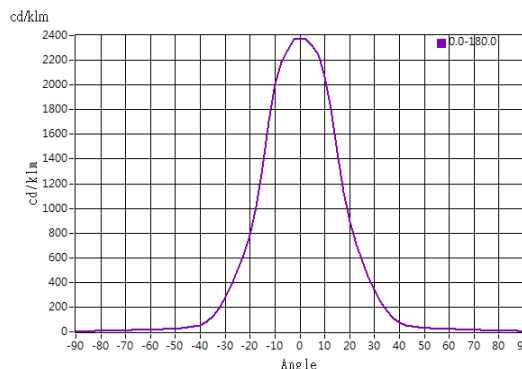

H: -1.5 mm

Illuminance At Distances

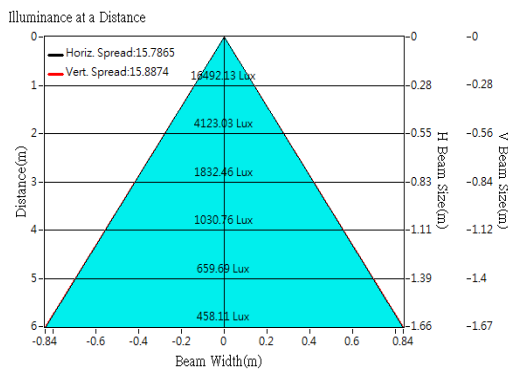

H: 6.0 mm

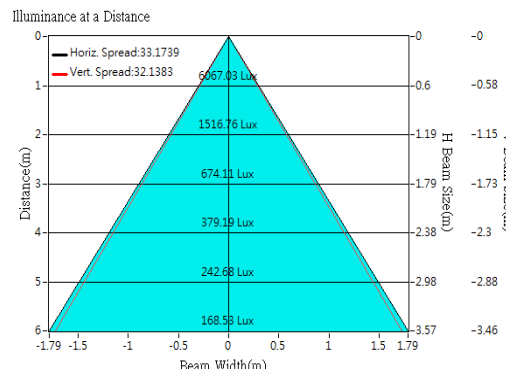

H: -1.5 mm



Optical Characteristics

Model Number	CKO-ZU15-110025-9301
LED	Fortimo SLM 1208 L15 G7
LES / LED Size	Φ 15 mm
FWHM (D50)	16°-24°
Field Angle (D10)	37°-52°
H (distance)	6.0mm~+0.5mm
Dimension	Φ =110 mm, Thickness=24.5 mm
Luminous Flux	2944 lm ~ 3071 lm (16° ~ 24°) Measured @ 26.3 W
Material	PC / UL94V2

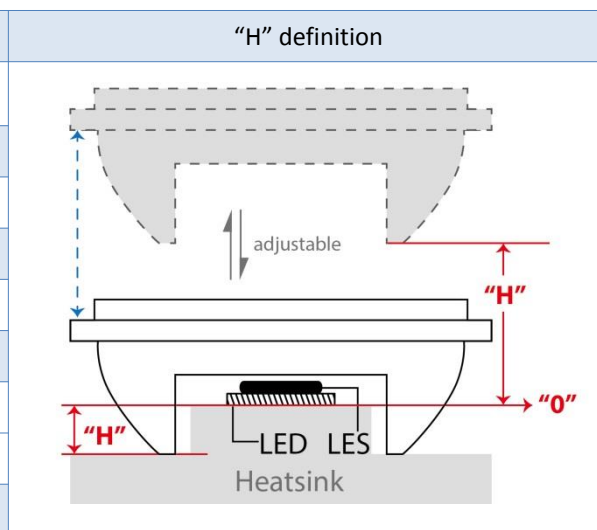

cd/klm

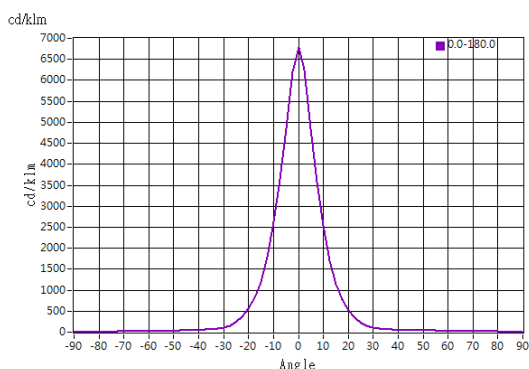

H: 6.0 mm

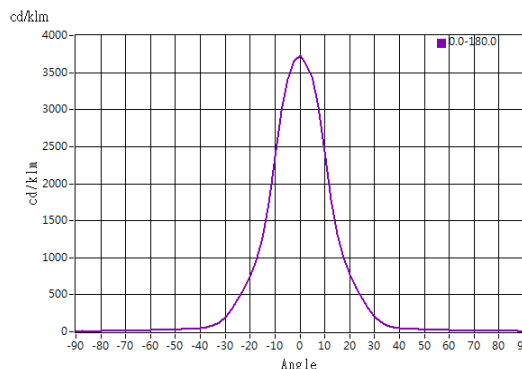

H: +0.5 mm

Illuminance At Distances

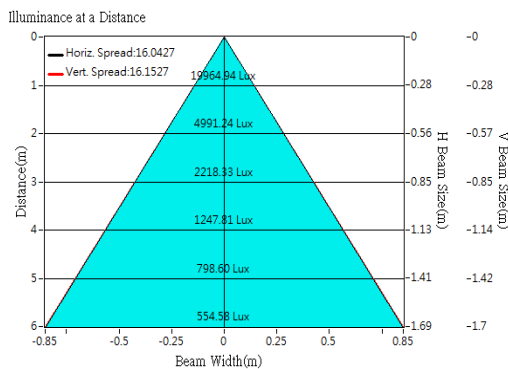

H: 6.0 mm

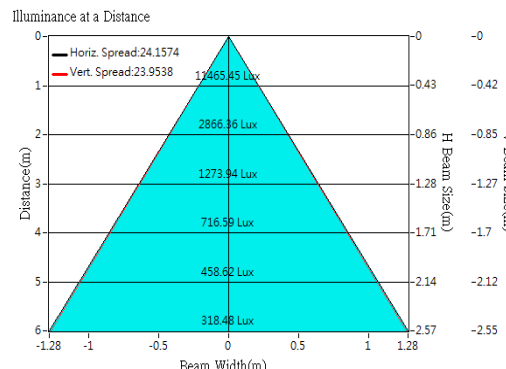

H: +0.5 mm



Optical Characteristics

Model Number	CKO-ZU15-110025-9301
LED	Fortimo SLM 1211 L19 G6
LES / LED Size	Φ 19 mm
FWHM (D50)	18°-44°
Field Angle (D10)	43°-81°
H (distance)	6.0mm~3.5mm
Dimension	Φ =110 mm, Thickness=24.5 mm
Luminous Flux	5045 lm ~ 3284 lm (18° ~ 44°) Measured @ 44 W
Material	PC / UL94V2

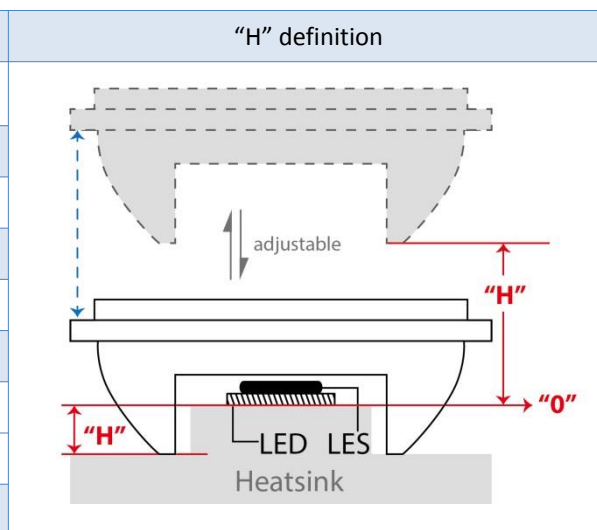

cd/klm

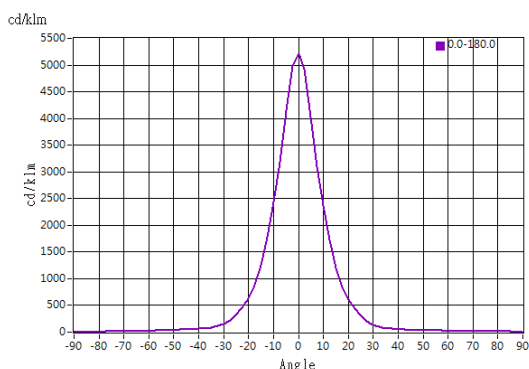

H: 6 mm

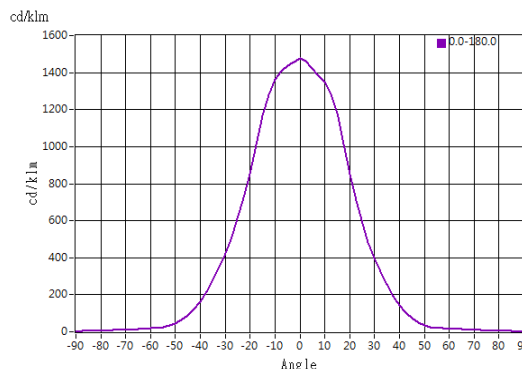

H: -3.5 mm

Illuminance At Distances

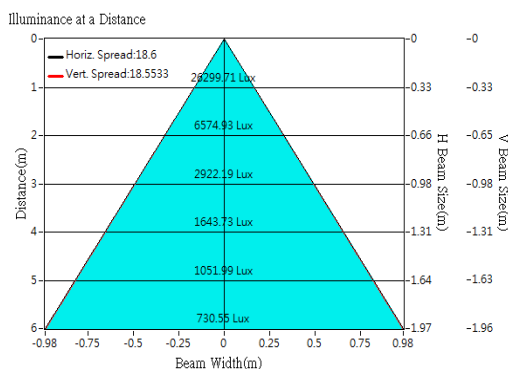

H: 6 mm

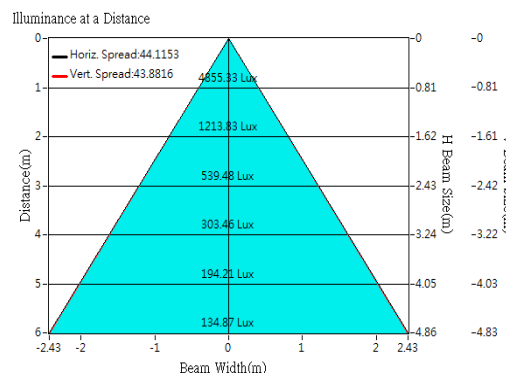

H: -3.5 mm