



Product Model Number

CKO-ZU16-085019-8501

✓ Model Number Definitions

CKO-XXXX-XXXXXX-XXXX



- A. Chun Kuang Optics Corp. Product
- B. Product Type: product abbreviation
Ex:
CH→CoB High Intensity
CC→CoB Compact
ZU→Multi-Angle Zooming Lens
HC→Holder for CoB LED

- C. Identity Code
- D. Lens / Fixture Size
Ex: 075026=Φ75mm / Thickness=26mm (round up)
- C. Serial Numbers

The lens datasheet is applicable for **Citizen LED**, that manufactured by Chun Kuang Optics Corp.

✓ Dimensions (mm) : Φ85 x 18.5

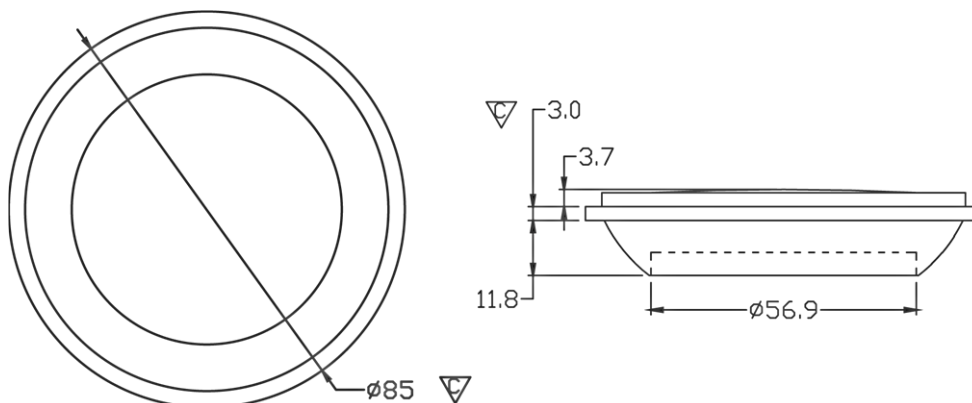

△:Critical Dimension



Optical Characteristics

Model Number	CKO-ZU16-085019-8501
LED	CLU 028
LES / LED Size	Φ 9.8 mm
FWHM (D50)	14°-26°
Field Angle (D10)	31°-50°
H (distance)	4.5mm~0.5mm
Dimension	Φ =85 mm, Thickness=18.5 mm
Luminous Flux	1770 lm ~1778 lm (14° -26 °) Measured @ 12.9 W
Material	PC / UL94V2

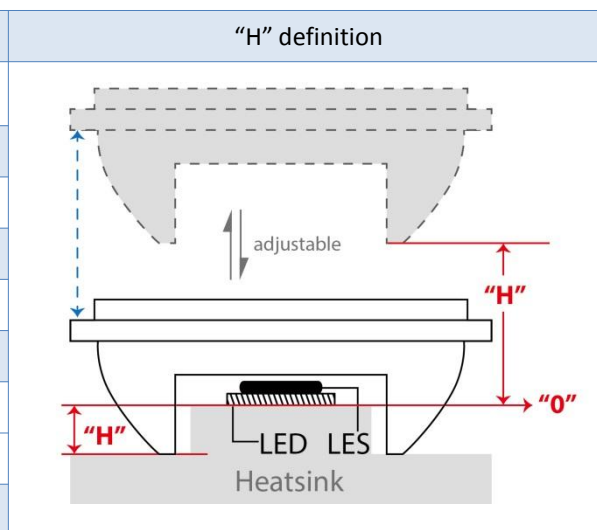

cd/klm

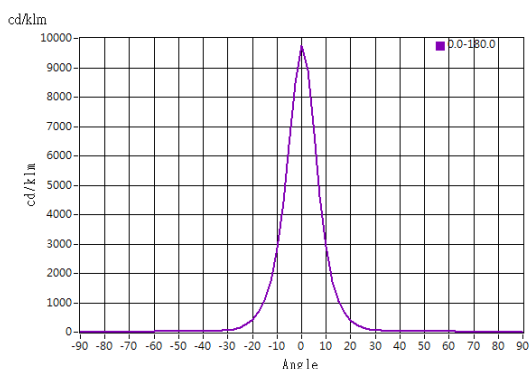

H: 4.5 mm

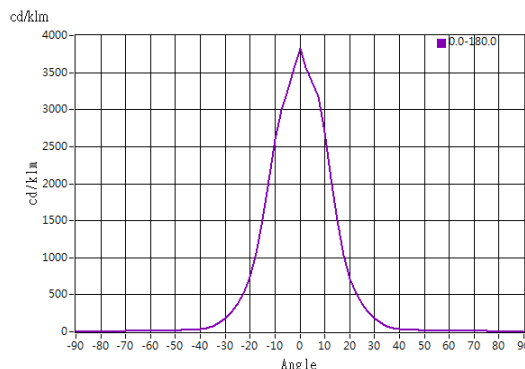

H: 0.5 mm

Illuminance At Distances

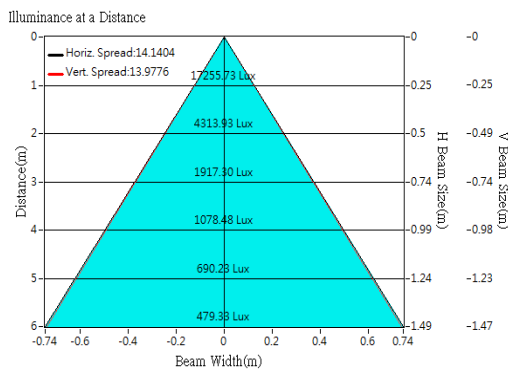

H:4.5 mm

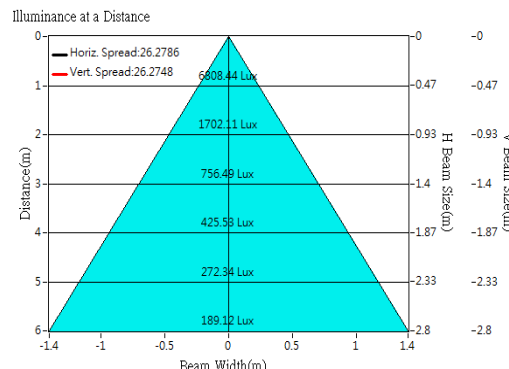

H: 0.5 mm



Optical Characteristics

Model Number	CKO-ZU16-085019-8501
LED	CLU 720
LES / LED Size	Φ 11 mm
FWHM (D50)	15°-30°
Field Angle (D10)	35°-58°
H (distance)	5.0mm~-0.1mm
Dimension	Φ =85 mm, Thickness=18.5 mm
Luminous Flux	3630 lm ~7397 lm (26° -47°) Measured @ 39.6 W
Material	PC / UL94V2

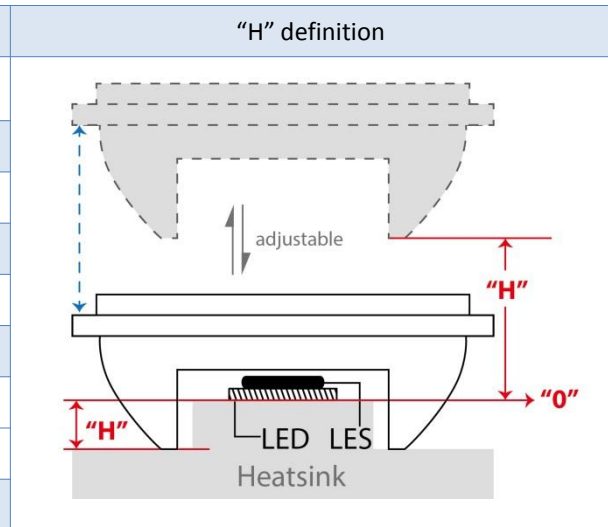

cd/klm

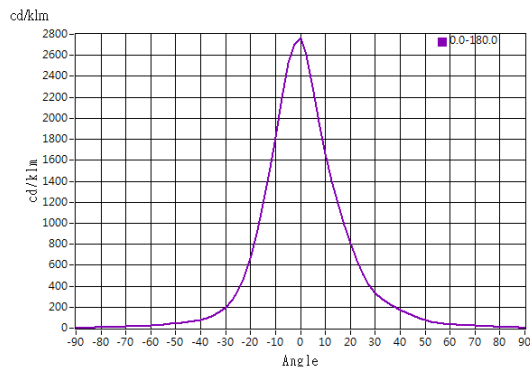

H: 4.5 mm

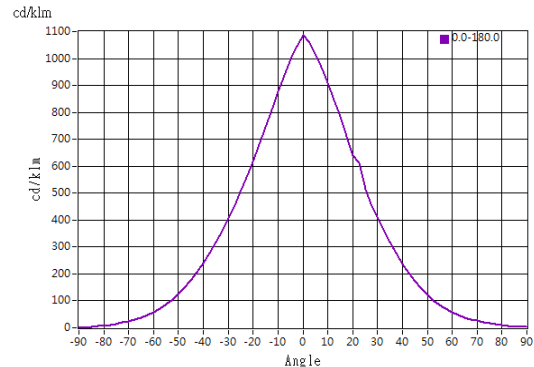

H: 2.6 mm

Illuminance At Distances

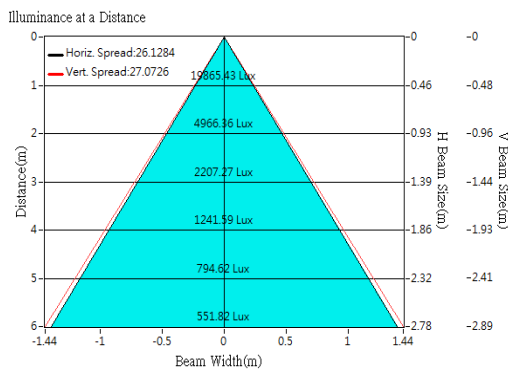

H: 4.5 mm

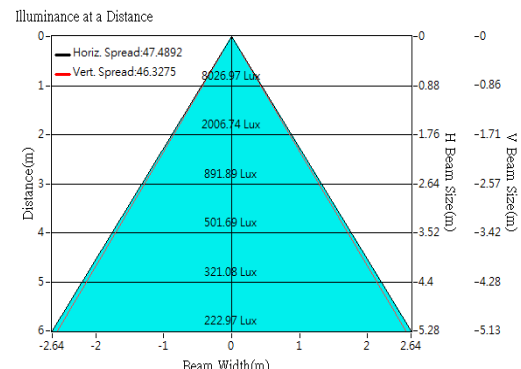

H: 2.6 mm



Optical Characteristics

Model Number	CKO-ZU16-085019-8501
LED	CLU 721
LES / LED Size	Φ 11 mm
FWHM (D50)	15°-30°
Field Angle (D10)	35°-58°
H (distance)	5.0mm~0.1mm
Dimension	Φ =85 mm, Thickness=18.5 mm
Luminous Flux	3630 lm ~4300 lm (26° -47°) Measured @ 40 W
Material	PC / UL94V2

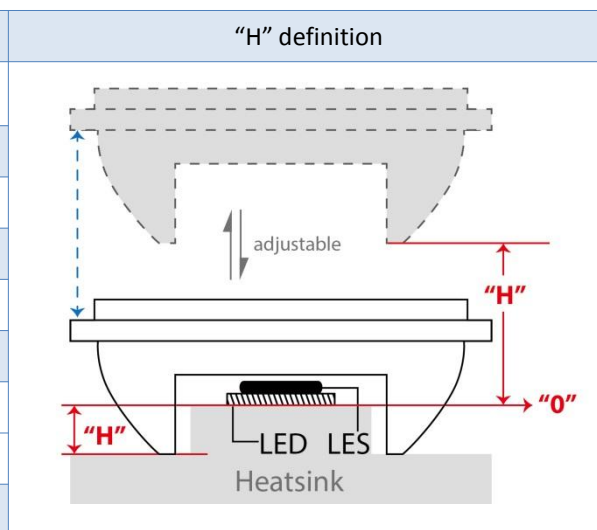

cd/klm

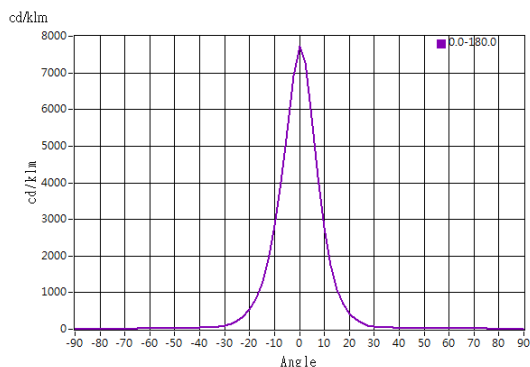

H: 5.0 mm

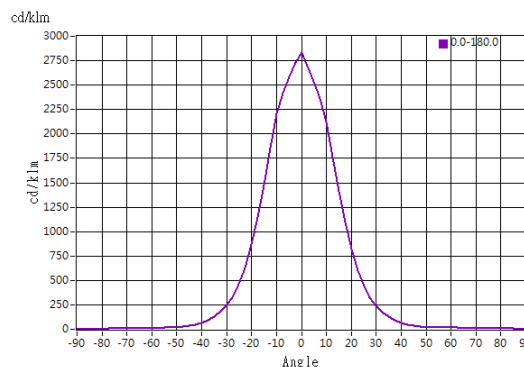

H: -0.1 mm

Illuminance At Distances



H:5.0 mm

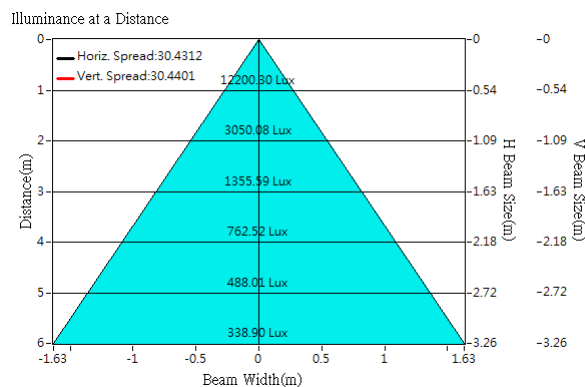

H:-0.1 mm



Optical Characteristics

Model Number	CKO-ZU16-085019-8501
LED	CLU 730
LES / LED Size	Φ 13 mm
FWHM (D50)	18°-51°
Field Angle (D10)	40°-86°
H (distance)	5.0mm~-2.6mm
Dimension	Φ =85 mm, Thickness=18.5 mm
Luminous Flux	5555 lm ~5425 lm (18° -51 °) Measured @ 64.7 W
Material	PC / UL94V2

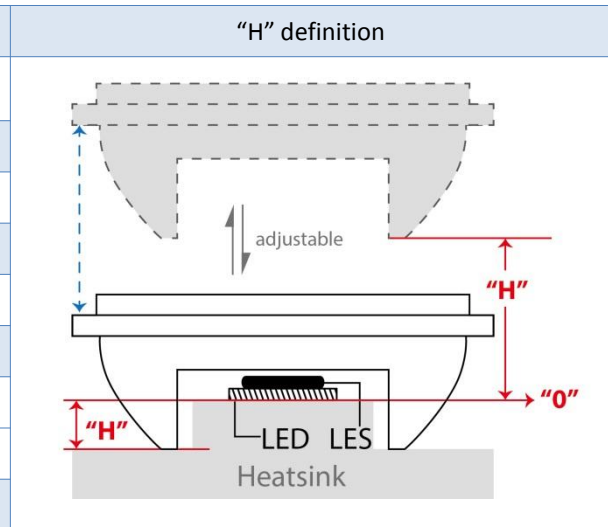

cd/klm

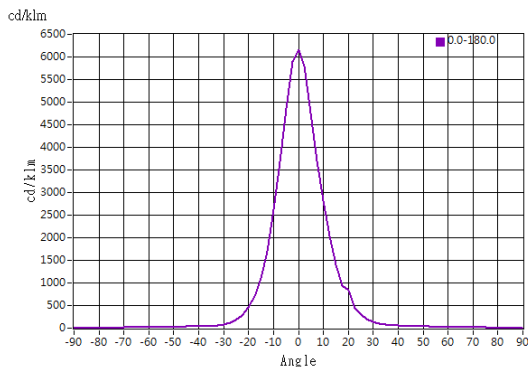

H: 5.0 mm

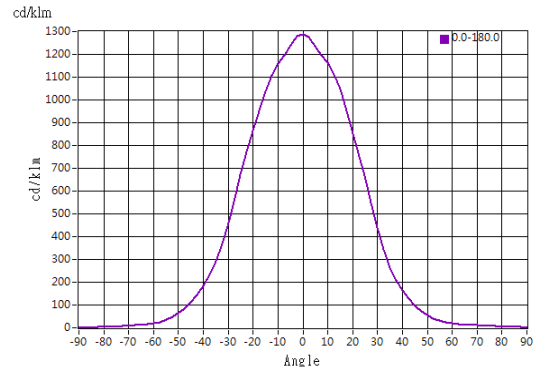

H: -2.6 mm

Illuminance At Distances

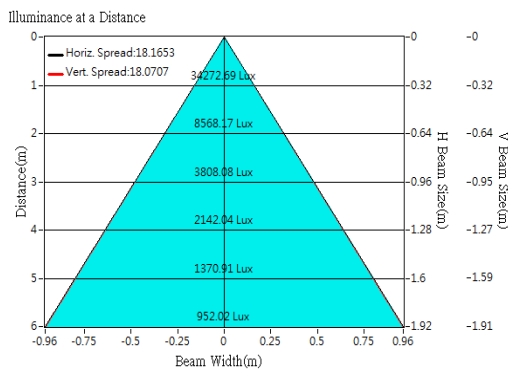

H:5.0 mm

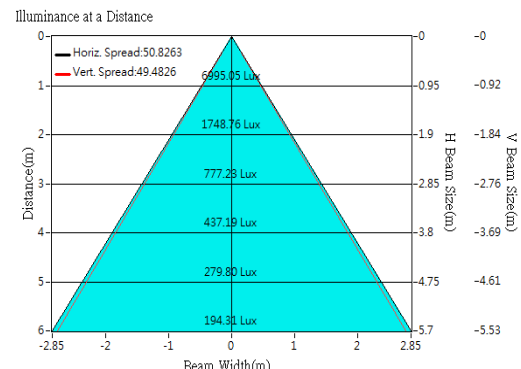

H:-2.6 mm



Optical Characteristics

Model Number	CKO-ZU16-085019-8501
LED	CLL 030
LES / LED Size	Φ 14.5 mm
FWHM (D50)	17°-50°
Field Angle (D10)	40°-87°
H (distance)	4.5mm~2.6mm
Dimension	Φ =85 mm, Thickness=18.5 mm
Luminous Flux	1186 lm ~1169 lm (17° -50 °) Measured @ 13.4 W
Material	PC / UL94V2

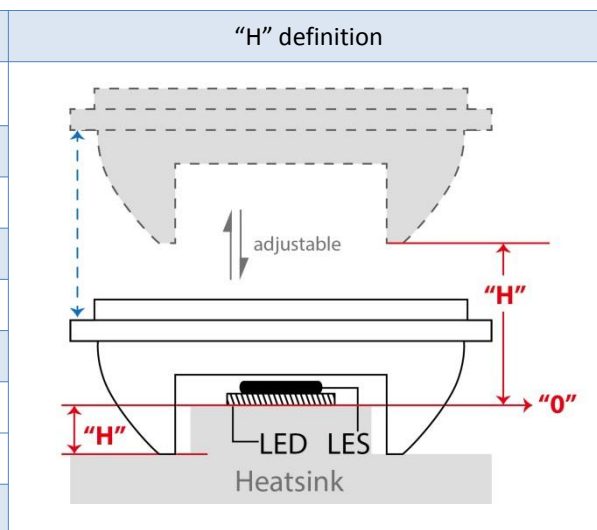

cd/klm

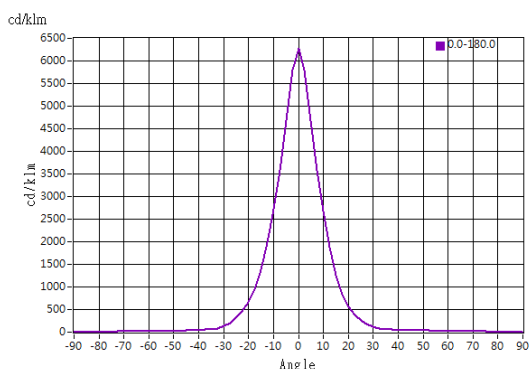

H: 4.5 mm

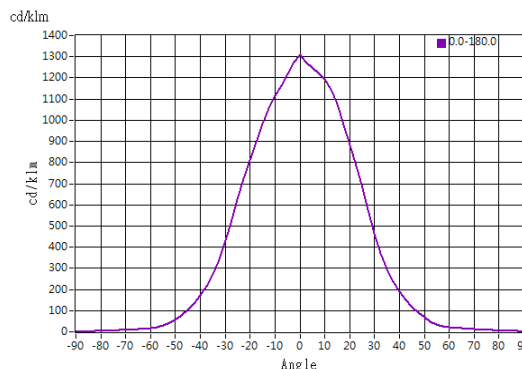

H: 2.6 mm

Illuminance At Distances

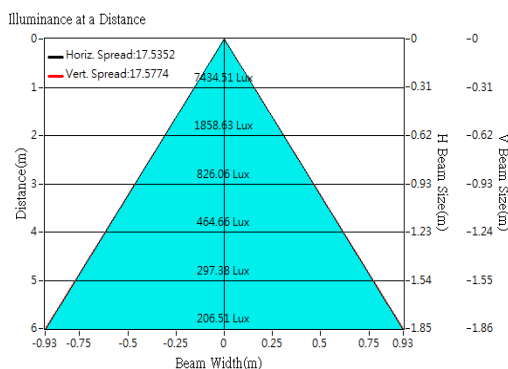

H: 4.5 mm

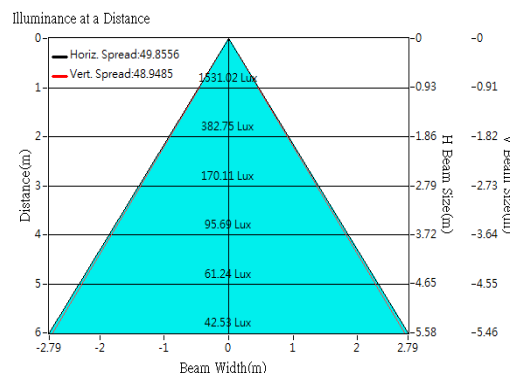

H: 2.6 mm



Optical Characteristics

Model Number	CKO-ZU16-085019-8501
LED	CLL 032
LES / LED Size	Φ 14.5 mm
FWHM (D50)	18°-47°
Field Angle (D10)	40°-83°
H (distance)	5.0mm~2.6mm
Dimension	Φ =85 mm, Thickness=18.5 mm
Luminous Flux	1365 lm ~1432 lm (18° -47 °) Measured @ 12.5 W
Material	PC / UL94V2

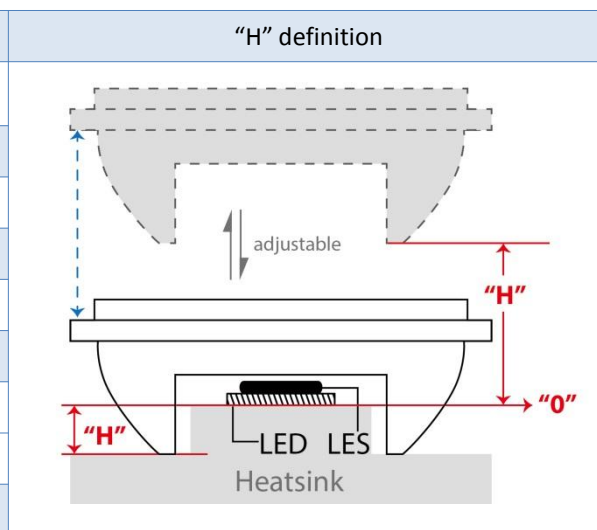

cd/klm

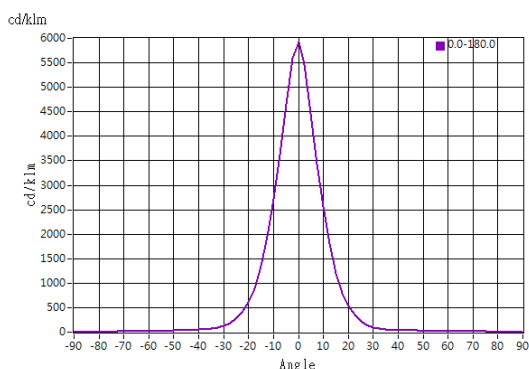

H: 5.0 mm

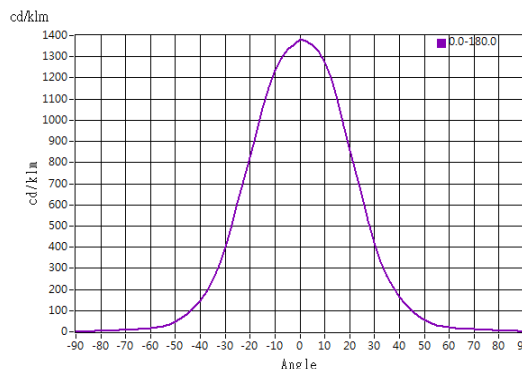

H: 2.6 mm

Illuminance At Distances

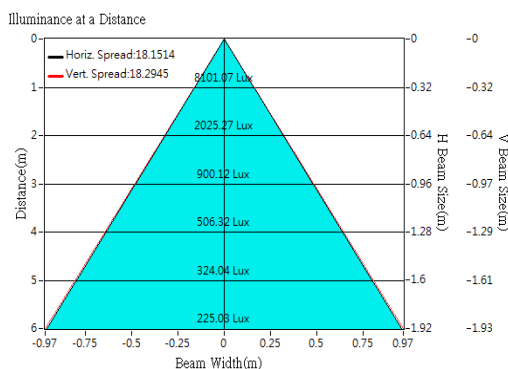

H: 5.0 mm

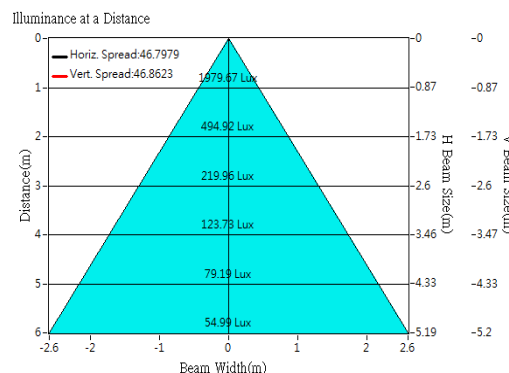

H: 2.6 mm



Optical Characteristics

Model Number	CKO-ZU16-085019-8501
LED	CLU 034
LES / LED Size	Φ 14.5 mm
FWHM (D50)	18°-50°
Field Angle (D10)	40°-87°
H (distance)	4.5mm~-2.6mm
Dimension	Φ =85 mm, Thickness=18.5 mm
Luminous Flux	2678 lm ~2485 lm (18° -50 °) Measured @ 25.1 W
Material	PC / UL94V2

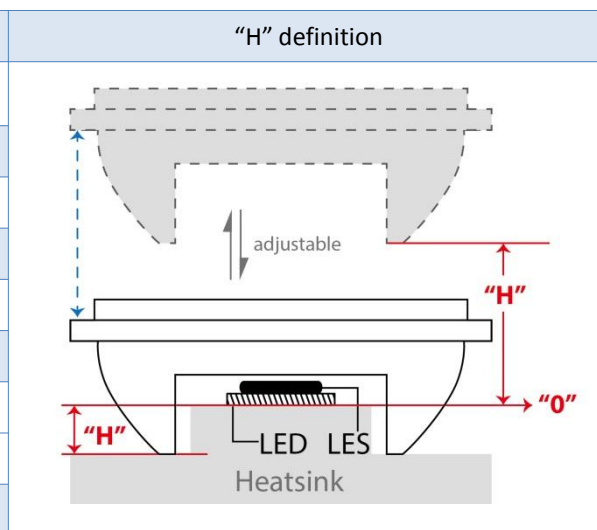

cd/klm

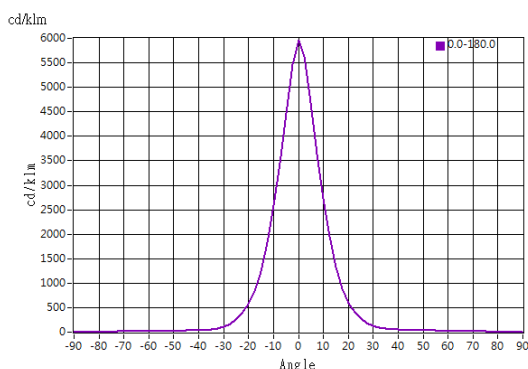

H: 4.5 mm

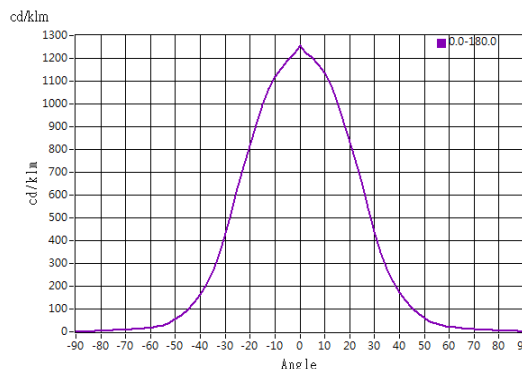

H: 2.6 mm

Illuminance At Distances

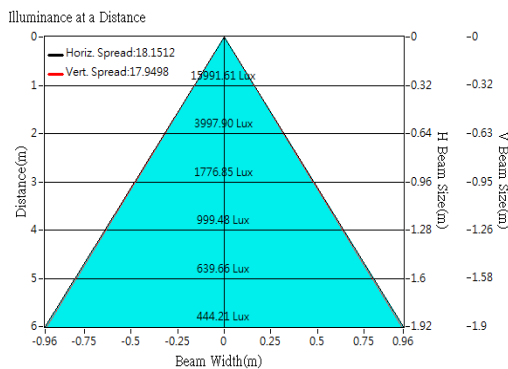

H:4.5 mm

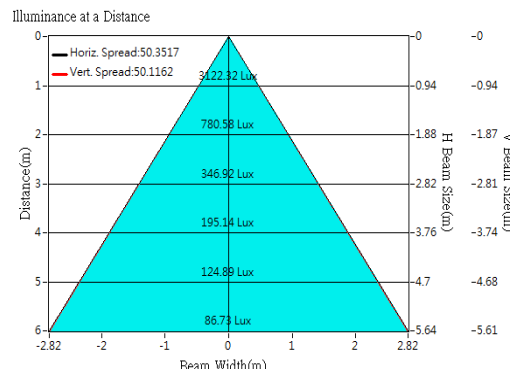

H:2.6 mm



Optical Characteristics

Model Number	CKO-ZU16-085019-8501
LED	CLU 038
LES / LED Size	Φ 14.5 mm
FWHM (D50)	17°-46°
Field Angle (D10)	40°-80°
H (distance)	4.5mm~2.6mm
Dimension	Φ =85 mm, Thickness=18.5 mm
Luminous Flux	3017 lm ~3037 lm (17° -46 °) Measured @ 25.7 W
Material	PC / UL94V2

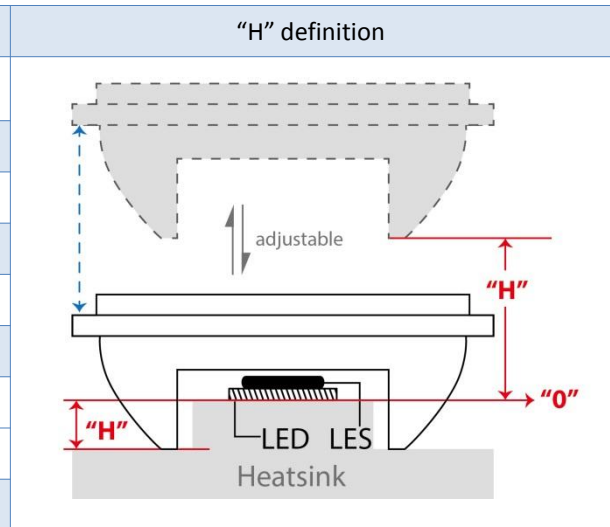

cd/klm

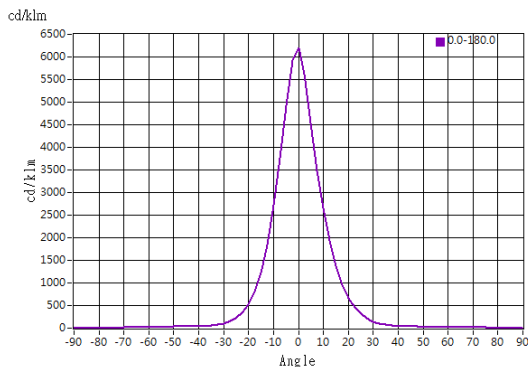

H: 4.5 mm

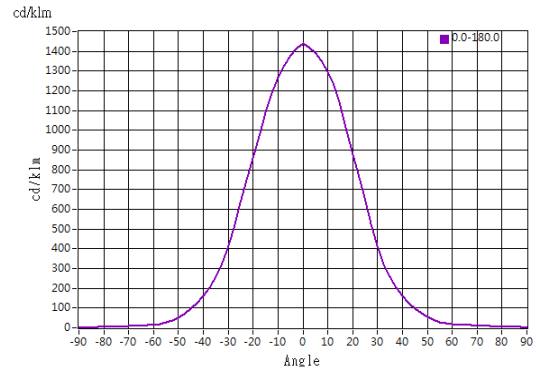

H:-2.6 mm

Illuminance At Distances

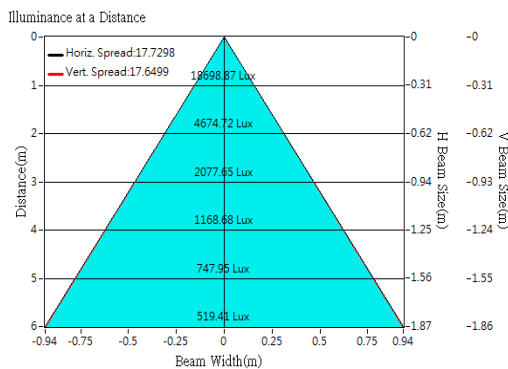

H: 4.5 mm

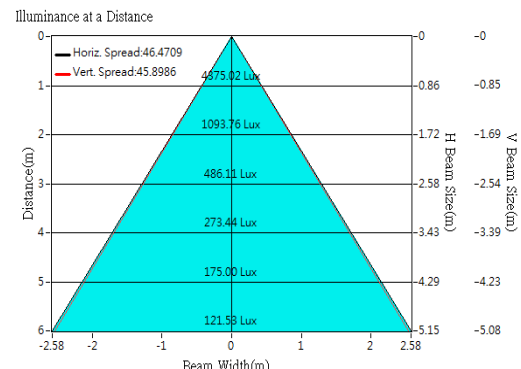

H:-2.6 mm



Optical Characteristics

Model Number	CKO-ZU16-085019-8501
LED	CLU 048
LES / LED Size	Φ 22 mm
FWHM (D50)	26°-47°
Field Angle (D10)	60°-104°
H (distance)	4.5mm~2.6mm
Dimension	Φ =85 mm, Thickness=18.5 mm
Luminous Flux	7194 lm ~7397 lm (26° -47 °) Measured @ 53.9 W
Material	PC / UL94V2

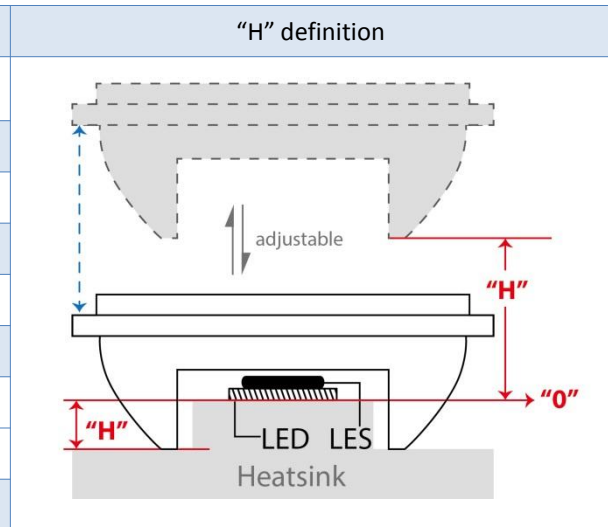

cd/klm

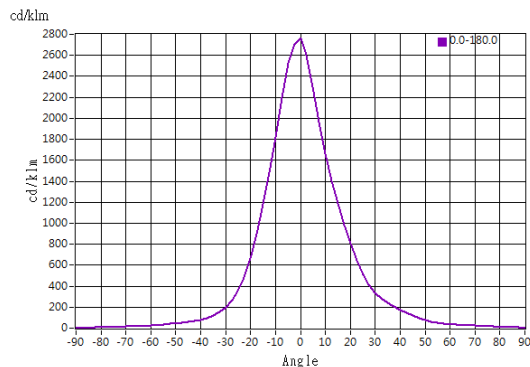

H: 4.5 mm

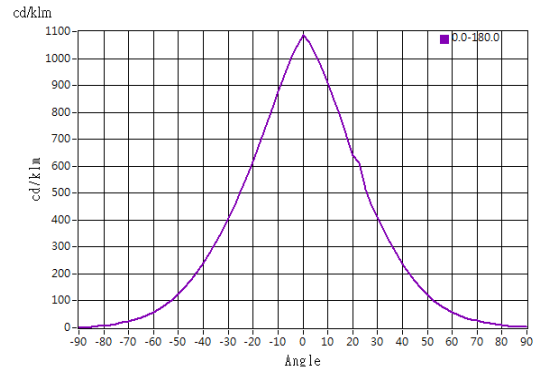

H: 2.6 mm

Illuminance At Distances

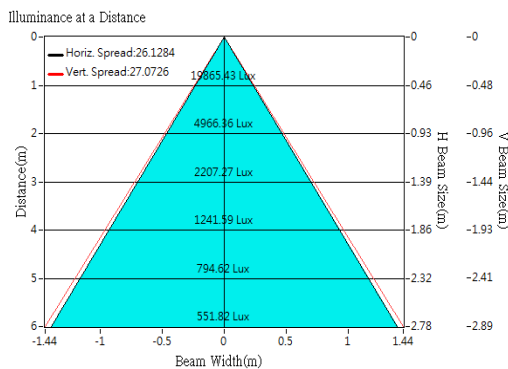

H: 4.5 mm

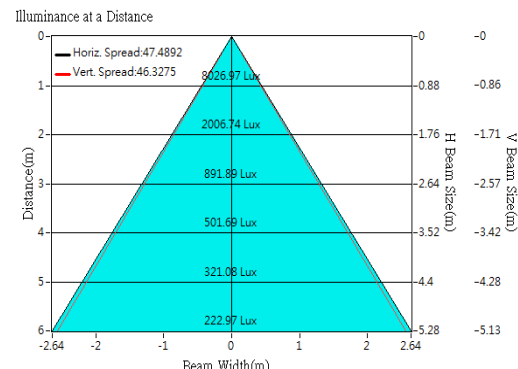

H: 2.6 mm