



Product Model Number

CKO-ZU16-085019-8501

✓ Model Number Definitions

CKO-XXXX-XXXXXX-XXXX



- A. Chun Kuang Optics Corp. Product
- B. Product Type: product abbreviation
Ex:
CH→CoB High Intensity
CC→CoB Compact
ZU→Multi-Angle Zooming Lens
HC→Holder for CoB LED

- C. Identity Code
- D. Lens / Fixture Size
Ex: 075026=Φ75mm / Thickness=26mm (round up)
- E. Serial Numbers

The lens datasheet is applicable for **Lumileds LED**, that manufactured by Chun Kuang Optics Corp.

✓ Dimensions (mm) : **Φ85 x 18.5**

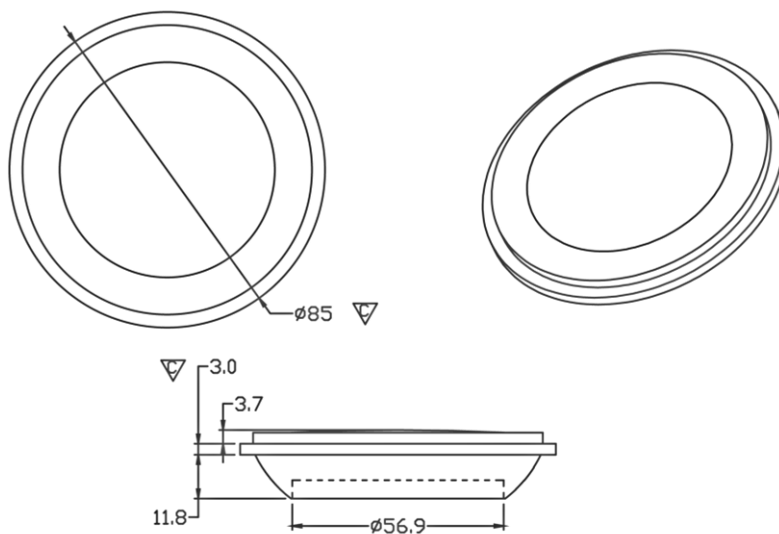

▽:Critical Dimension



Optical Characteristics

Model Number	CKO-ZU16-085019-8501
LED	Luxeon 1205
LES / LED Size	Φ 13 mm
FWHM (D50)	17°-46°
Field Angle (D10)	38°-79°
H (distance)	5.0mm~2.6mm
Dimension	Φ =85 mm, Thickness=18.5 mm
Luminous Flux	2091 lm ~ 2186 lm (17°-46°) Measured @ 22.1 W
Material	PC / UL94V2

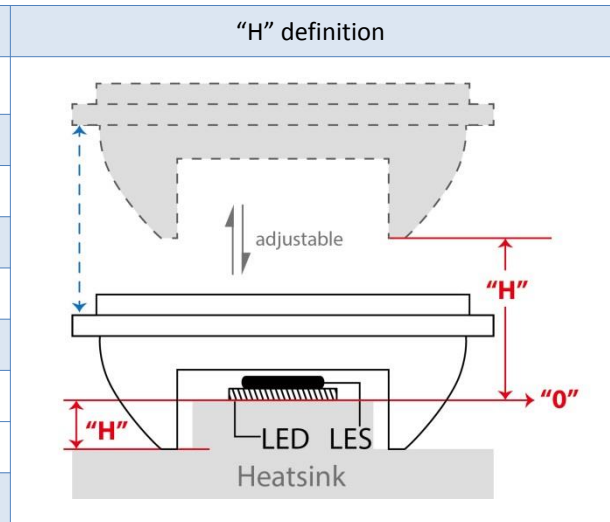

cd/klm

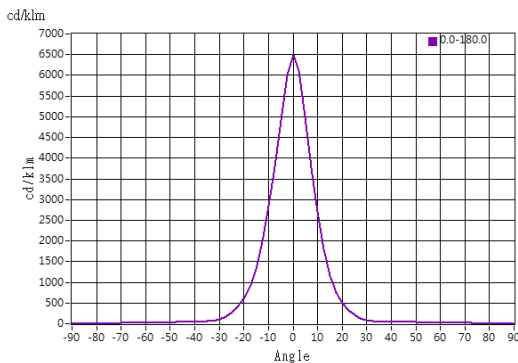

H: 5.0 mm

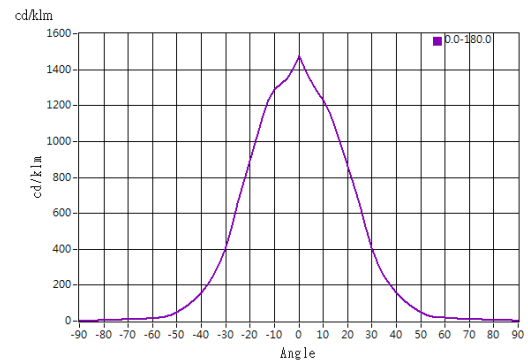

H: -2.6 mm

Illuminance At Distances

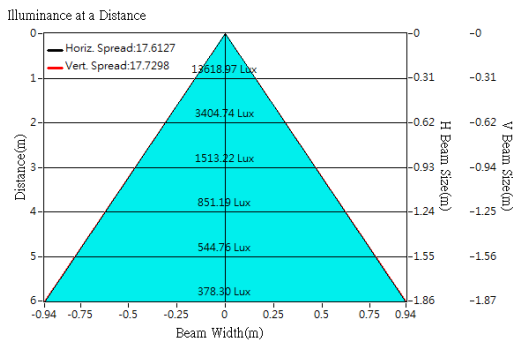

H: 5.0 mm

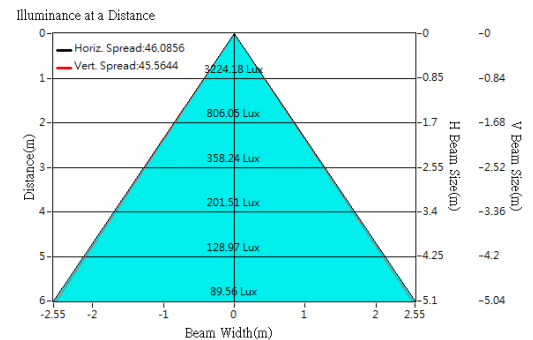

H: -2.6 mm



Optical Characteristics

Model Number	CKO-ZU16-085019-8501
LED	Luxeon 1208
LES / LED Size	Φ 15 mm
FWHM (D50)	19°-49°
Field Angle (D10)	43°-87°
H (distance)	5.0mm~2.6mm
Dimension	Φ =85 mm, Thickness=18.5 mm
Luminous Flux	2438 lm ~ 2471 lm (19°-49°) Measured @ 25 W
Material	PC / UL94V2

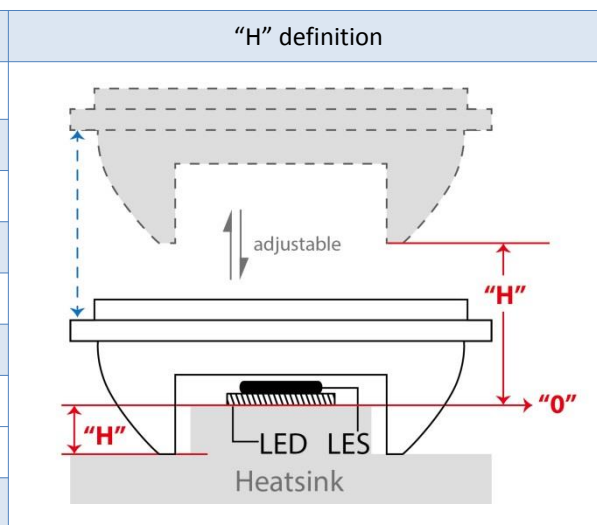

cd/klm

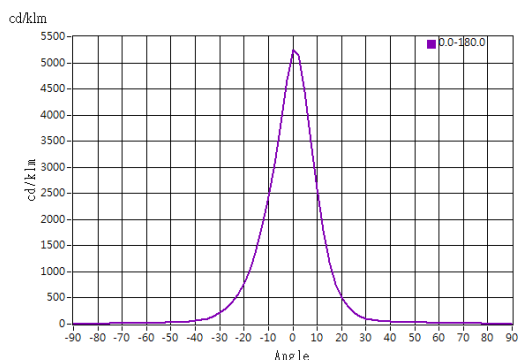

H: 5.0 mm

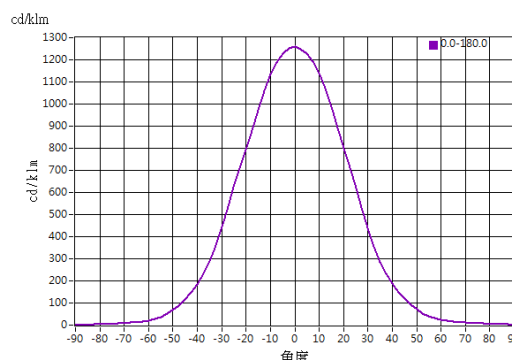

H: -2.6 mm

Illuminance At Distances

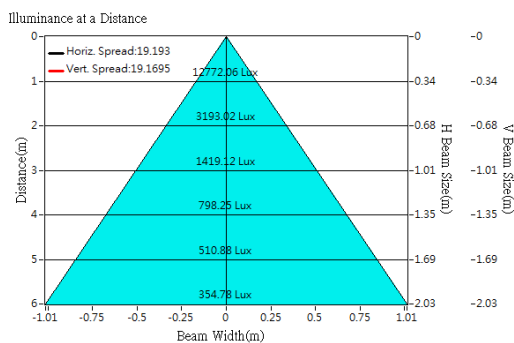

H: 5.0 mm

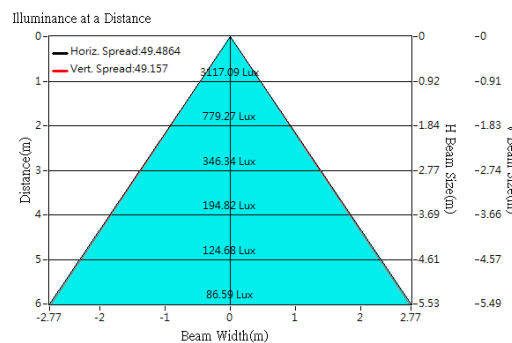

H: -2.6 mm