



Product Model Number

CKO-ZU16-085019-8501

✓ Model Number Definitions

CKO-XXXX-XXXXXX-XXXX



- A. Chun Kuang Optics Corp. Product
- B. Product Type: product abbreviation
Ex:
CH→CoB High Intensity
CC→CoB Compact
ZU→Multi-Angle Zooming Lens
HC→Holder for CoB LED

- C. Identity Code
- D. Lens / Fixture Size
Ex: 075026=Φ75mm / Thickness=26mm (round up)
- C. Serial Numbers

The lens datasheet is applicable for **Philips LED**, that manufactured by Chun Kuang Optics Corp.

✓ Dimensions (mm) : Φ85 x 18.5

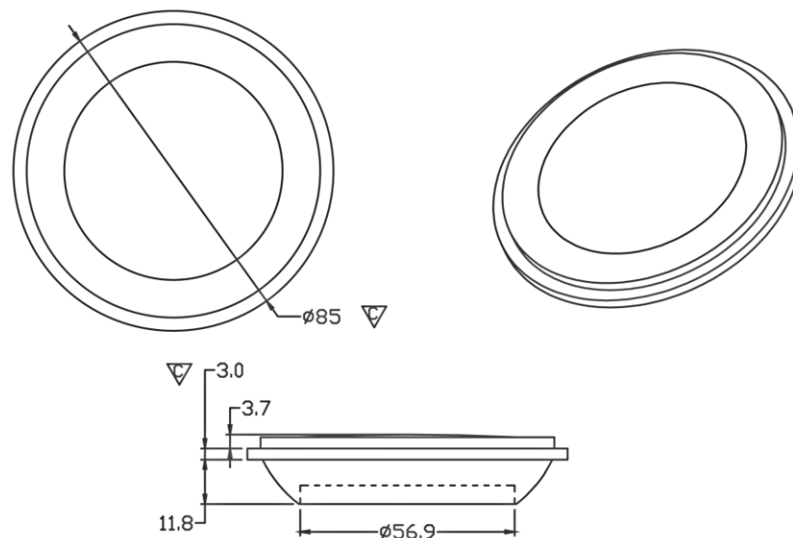

▽:Critical Dimension



Optical Characteristics

Model Number	CKO-ZU16-085019-8501
LED	Fortimo SLM 1204 L09 G7
LES / LED Size	Φ 9 mm
FWHM (D50)	13°-26°
Field Angle (D10)	30°-50°
H (distance)	5.4mm~+0.5mm
Dimension	Φ =85 mm, Thickness=18.5 mm
Luminous Flux	2697 lm ~ 2125 lm (13° ~ 26°) Measured @ 26.2 W
Material	PC / UL94V2

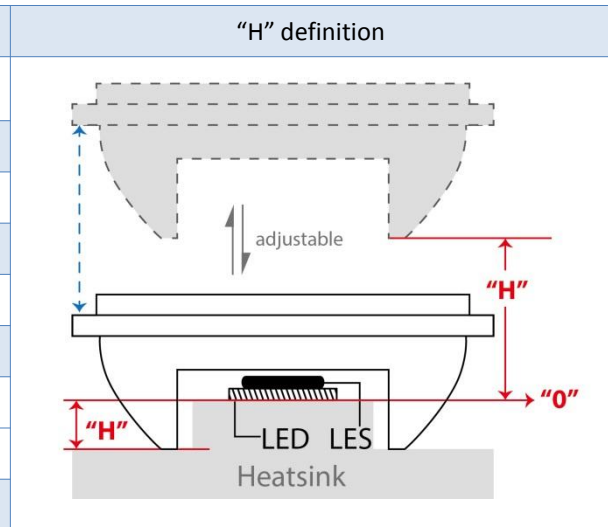

cd/klm

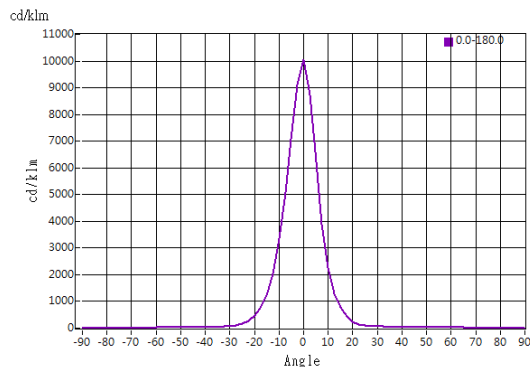

H: 5.4 mm

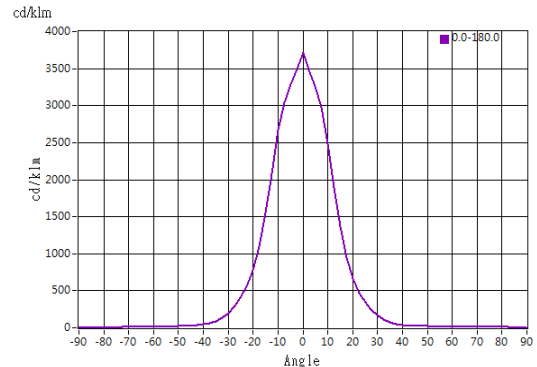

H: +0.5 mm

Illuminance At Distances

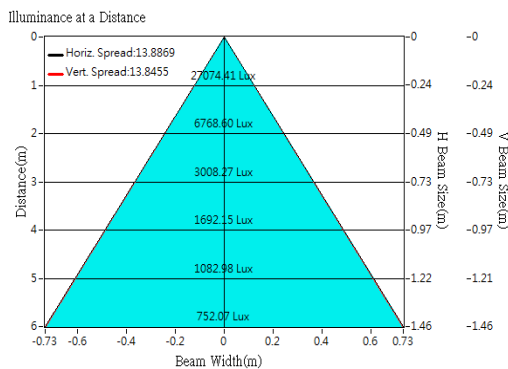

H: 5.4 mm

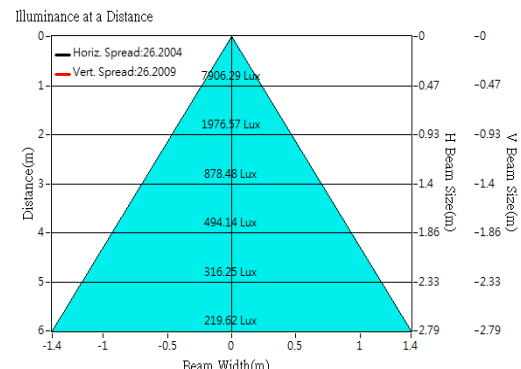

H: +0.5 mm



Optical Characteristics

Model Number	CKO-ZU16-085019-8501
LED	Fortimo SLM 1205 L13 G6
LES / LED Size	Φ 13 mm
FWHM (D50)	18°-46°
Field Angle (D10)	40°-83°
H (distance)	5.0mm~-2.6mm
Dimension	Φ =85 mm, Thickness=18.5 mm
Luminous Flux	2278 lm ~ 2357 lm (18° ~ 46°) Measured @ 17.8 W
Material	PC / UL94V2

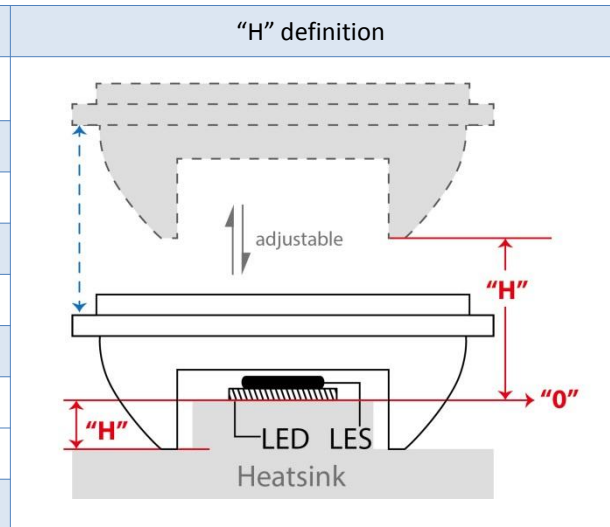

cd/klm

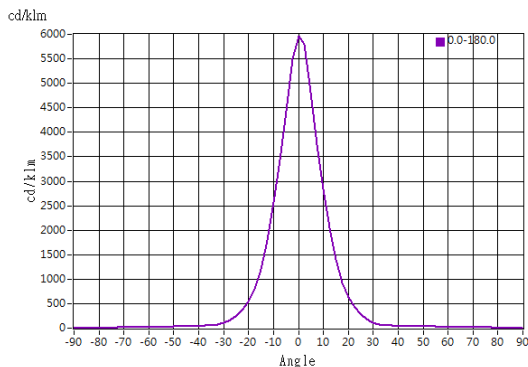

H: 5.0 mm

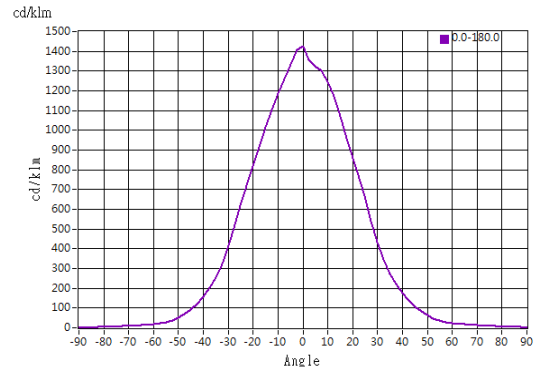

H: -2.6 mm

Illuminance At Distances

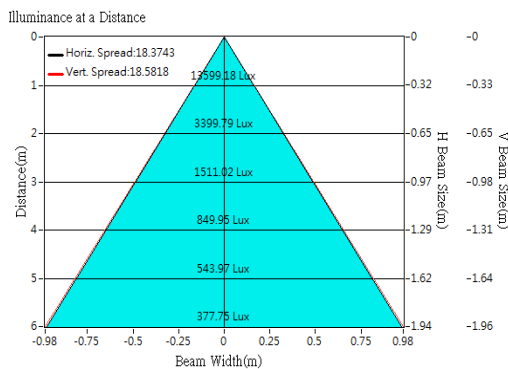

H: 5.0 mm

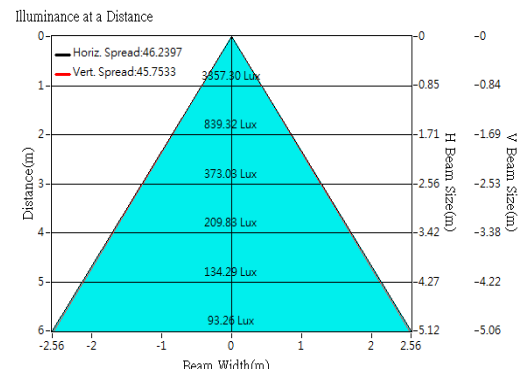

H: -2.6 mm



Optical Characteristics

Model Number	CKO-ZU16-085019-8501
LED	Fortimo SLM 1205 L13 G7
LES / LED Size	Φ 13 mm
FWHM (D50)	19°-45°
Field Angle (D10)	40°-82°
H (distance)	5.4mm~-2.6mm
Dimension	Φ =85 mm, Thickness=18.5 mm
Luminous Flux	2480 lm ~ 2594 lm (19° ~ 45°) Measured @ 17.2 W
Material	PC / UL94V2

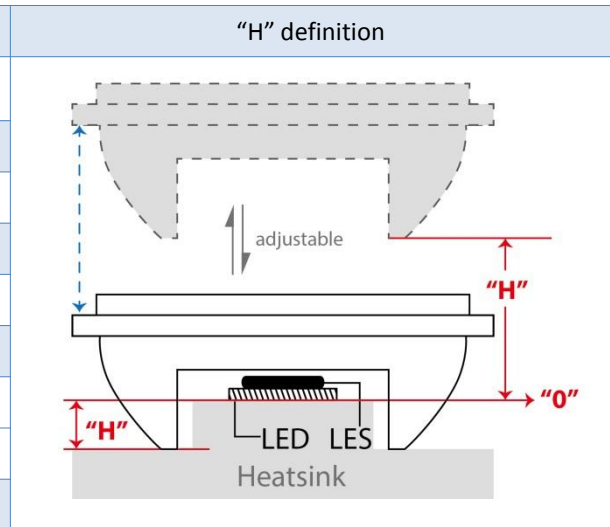

cd/klm

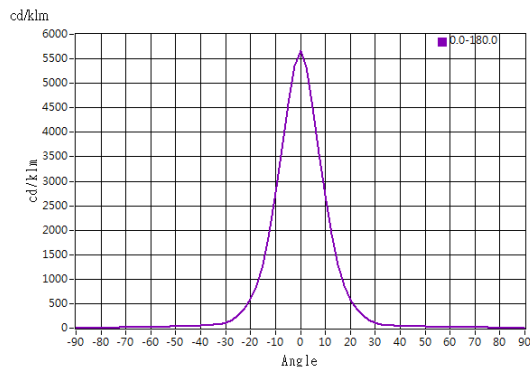

H: 5.4 mm

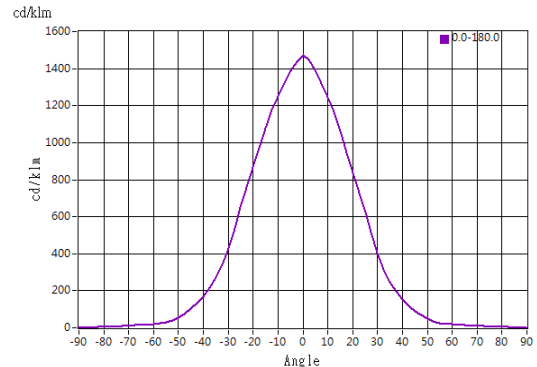

H: -2.6 mm

Illuminance At Distances

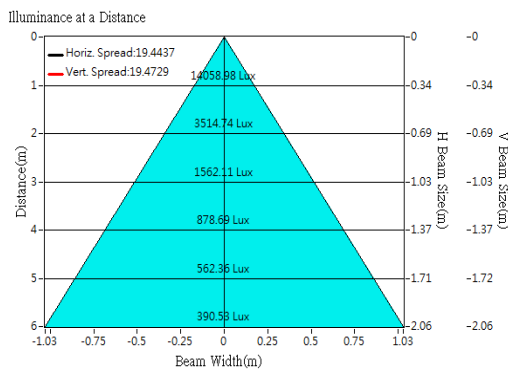

H: 5.4 mm

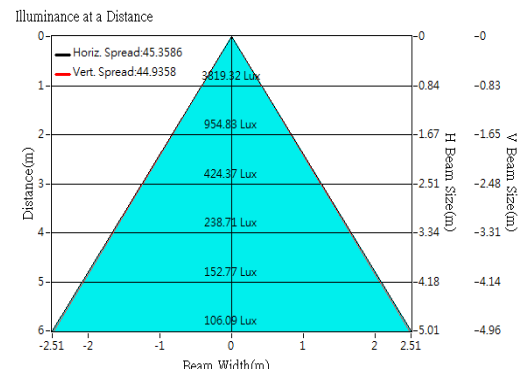

H: -2.6 mm



Optical Characteristics

Model Number	CKO-ZU16-085019-8501
LED	Fortimo SLM 1208 L15 G6
LES / LED Size	Φ 15 mm
FWHM (D50)	20°-46°
Field Angle (D10)	44°-85°
H (distance)	4.0mm~-2.6mm
Dimension	Φ =85 mm, Thickness=18.5 mm
Luminous Flux	2741 lm ~ 2820 lm (20° ~ 46°) Measured @ 26.8 W
Material	PC / UL94V2

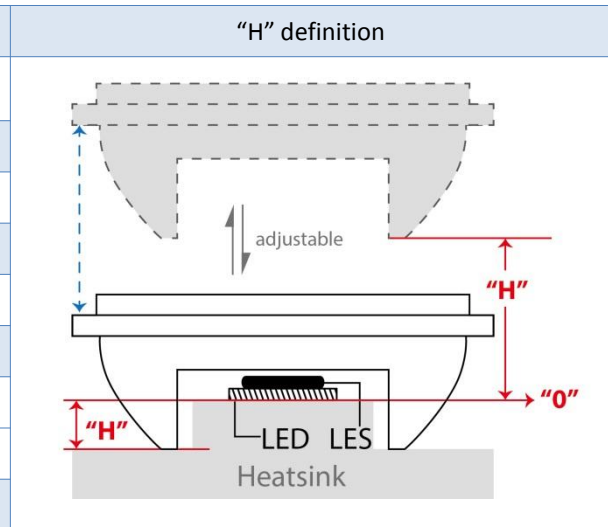

cd/klm

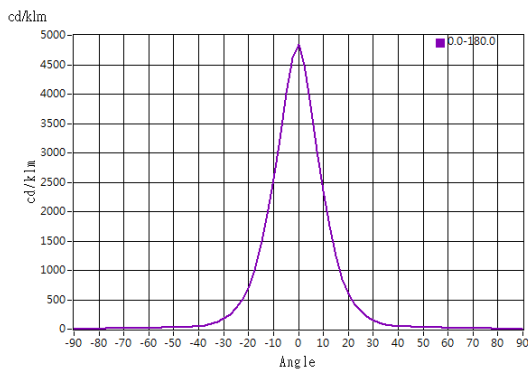

H: 4.0 mm

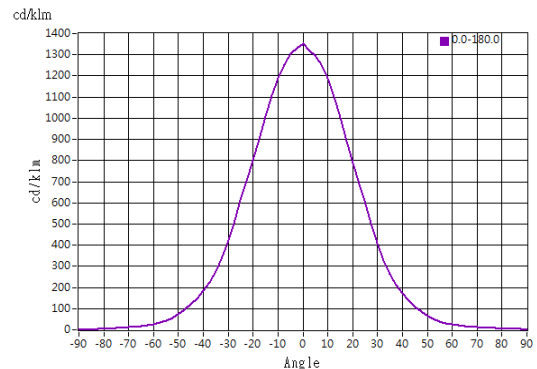

H: -2.6 mm

Illuminance At Distances

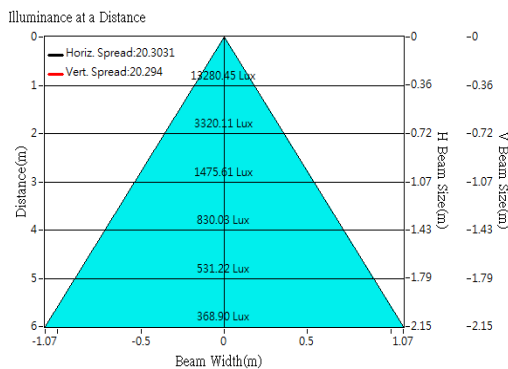

H: 4.0 mm

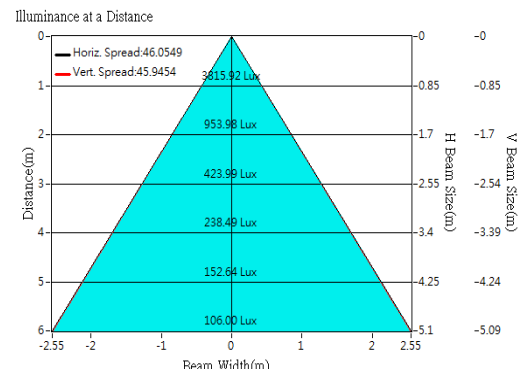

H: -2.6 mm



Optical Characteristics

Model Number	CKO-ZU16-085019-8501
LED	Fortimo SLM 1208 L15 G7
LES / LED Size	Φ 15 mm
FWHM (D50)	20°-47°
Field Angle (D10)	43°-86°
H (distance)	4.5mm~-2.6mm
Dimension	Φ =85 mm, Thickness=18.5 mm
Luminous Flux	3107 lm ~ 3308 lm (20° ~ 47°) Measured @ 26.5 W
Material	PC / UL94V2

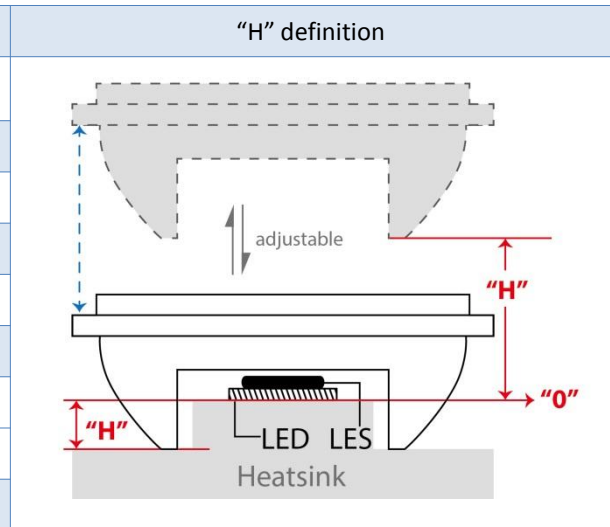

cd/klm

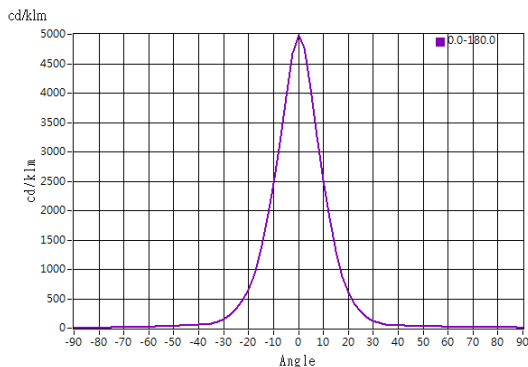

H: 4.5 mm

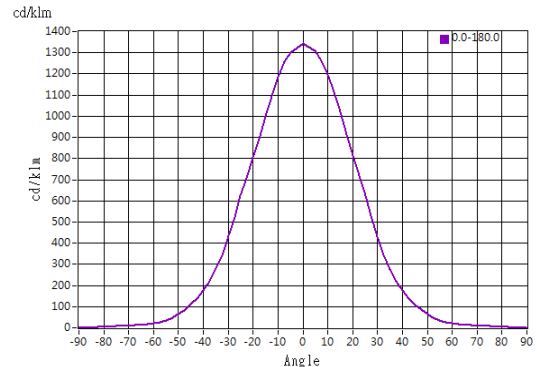

H: -2.6 mm

Illuminance At Distances

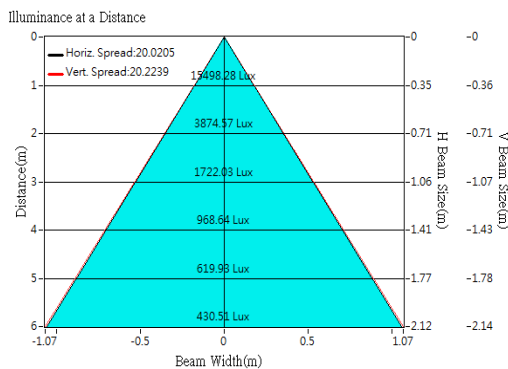

H: 4.5 mm

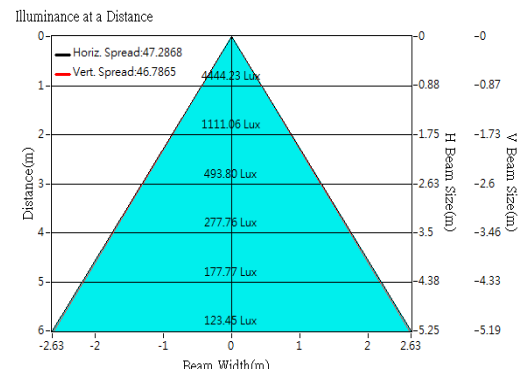

H: -2.6 mm



Optical Characteristics

Model Number	CKO-ZU16-085019-8501
LED	Fortimo SLM 1211 L19 G6
LES / LED Size	Φ 19 mm
FWHM (D50)	24°-46°
Field Angle (D10)	54°-95°
H (distance)	4.0mm~2.6mm
Dimension	Φ =85 mm, Thickness=18.5 mm
Luminous Flux	3227 lm ~ 5324 lm (24° ~ 46°) Measured @ 44.7 W
Material	PC / UL94V2

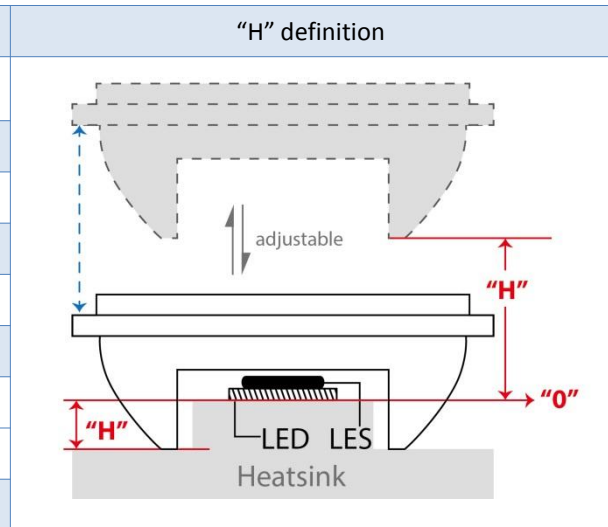

cd/klm

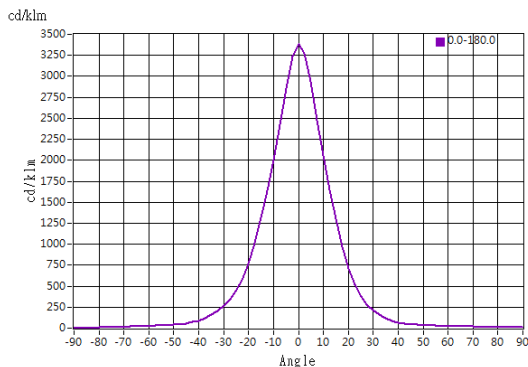

H: 4.0 mm

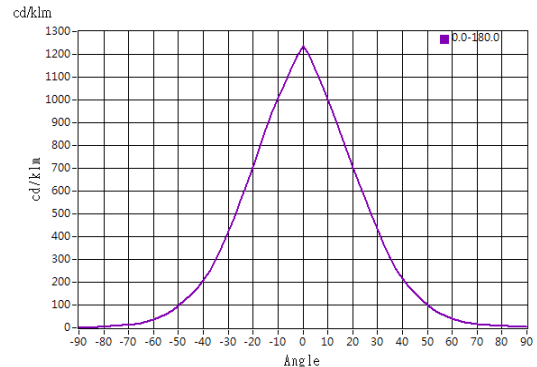

H: -2.6 mm

Illuminance At Distances

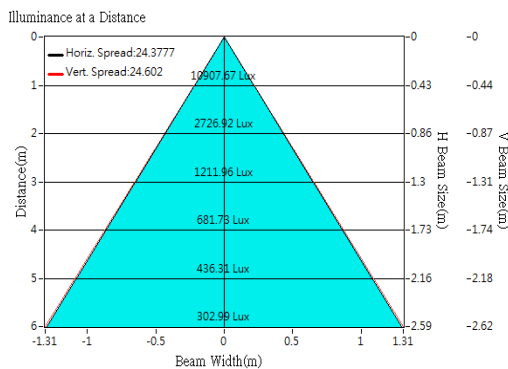

H: 4.0 mm

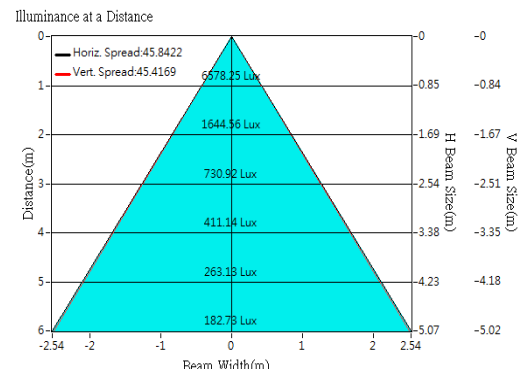

H: -2.6 mm